



Universal cylinder model YS

Single-acting with spring return,
5 - 100 t

Robust construction with long guides allow the units to withstand abuse and better tolerate eccentric and side loading, yet is convenient to use with only one quick-release coupler hose connection and a spring return.

Universal cylinders are designed for all jobs where high forces but compact dimensions are required: e.g. straightening of steel constructions, removing of parts like shafts, axles, lifting, positioning, weighing, supporting, testing as well as for all general assembly and repair applications. Due to the various mounting threads the cylinders can easily be installed in clamping devices, welding fixtures, frame presses etc.

Features

- Yale ChroMo-Design.
- Operating pressure max. 700 bar.
- Single-acting with spring return.
- Robust design with long piston bearings to withstand eccentric loading.
- Cylinder body and piston are made from massive chromium-molybdenum steel and heat treated.
- Hard-chromium plated piston with replaceable, heat treated saddle.
- Metric mounting threads on cylinder collar, in the base and piston rod (5 to 30 t).
- Stop ring can bear full capacity (pressure) and is fitted with dirt wiper.
- Interchangeable hardened saddle.
- Dirt wiper protect against dirt.
- Oil port thread: 3/8 NPT.
- Incl. female coupler half model CFY-1.
- Models YS-50/100 and YS-50/160 with carrying handle.
- Models YS-50/320 to YS-100/200 with lifting rings.

! A selection chart "cylinder/hand pumps" can be found on pages 261 to 263.



Technical data model YS

Cylinder size	Model	EAN-No. 4025092*	Capacity	Lift	Effective plunger area	Oil volume max.	Closed height	Cylinder outside diameter	Weight
t			kN	mm	cm ²	cm ³	mm	mm	kg
5	YS-5/15	*150002	50	15	7.2	11	45	41	0.9
5	YS-5/25	*150019	50	25	7.2	18	97	42	1.0
5	YS-5/75	*150026	50	75	7.2	53	157	42	1.5
5	YS-5/127	*150033	50	127	7.2	90	214	42	2.0
5	YS-5/180	*150040	50	180	7.2	127	267	42	2.4
10	YS-10/25	*150057	100	25	14.3	37	90	57	1.6
10	YS-10/50	*150064	100	50	14.3	73	125	57	2.1
10	YS-10/100	*150071	100	100	14.3	146	178	57	2.8
10	YS-10/150	*150088	100	150	14.3	218	250	57	4.1
10	YS-10/200	*150095	100	200	14.3	291	300	57	4.7
10	YS-10/250	*150101	100	250	14.3	363	352	57	5.5
10	YS-10/300	*150118	100	300	14.3	436	407	57	6.3
15	YS-15/25	*150125	150	25	21.5	53	110	67	2.7
15	YS-15/50	*150132	150	50	21.5	106	140	67	3.3
15	YS-15/100	*150149	150	100	21.5	213	190	67	4.3
15	YS-15/150	*150156	150	150	21.5	319	260	67	5.8
15	YS-15/200	*150163	150	200	21.5	425	310	67	7.0
15	YS-15/250	*150170	150	250	21.5	531	365	67	8.0
15	YS-15/300	*150187	150	300	21.5	637	420	67	9.0
15	YS-15/350	*150194	150	350	21.5	744	472	67	10.0
23	YS-23/25	*150200	230	25	32.9	83	116	85	5.0
23	YS-23/50	*150217	230	50	32.9	166	150	85	6.0
23	YS-23/100	*150224	230	100	32.9	332	202	85	7.5
23	YS-23/160	*150231	230	160	32.9	531	277	85	10.0
23	YS-23/210	*150248	230	210	32.9	697	330	85	12.0
23	YS-23/250	*150255	230	250	32.9	830	376	85	13.5
23	YS-23/300	*150262	230	300	32.9	996	428	85	15.0
23	YS-23/345	*150279	230	345	32.9	1145	477	85	16.5
30	YS-30/125	*150286	300	125	42.9	552	245	102	13.0
30	YS-30/200	*150293	300	200	42.9	884	325	102	17.0
50	YS-50/50	*150309	500	50	71.5	355	170	125	15.0
50	YS-50/100	*150316	500	100	71.5	709	220	125	19.0
50	YS-50/160	*150323	500	160	71.5	1135	285	125	24.0
50	YS-50/320	*150330	500	320	71.5	2269	460	125	37.0
70	YS-70/150	*150347	700	150	100.0	1478	285	146	32.0
70	YS-70/330	*150354	700	330	100.0	3252	490	146	52.0
100	YS-100/100	*150378	1000	100	143.0	1432	275	180	43.0
100	YS-100/200	*150361	1000	200	143.0	2863	375	180	64.0



Accessories for cylinders series YS like lifting claws, piston plates, extension tubes, support plates and threaded flanges are also available on request.



Support plates are available as accessories.



Threaded flanges are available as accessories.

For accessories for cylinders series YS please see pages 206 to 208.

Hydraulic Jacks & Tools Hydraulic cylinders, single-acting

Dimensions model YS

Model	YS-5/15	YS-5/25	YS-5/75	YS-5/127	YS-5/180	YS-10/25	YS-10/50	YS-10/100	YS-10/150	YS-10/200
A, mm	45	97	157	214	267	90	125	178	250	300
B, mm	60	122	232	341	447	115	175	278	400	500
C, mm	45	92	152	209	262	88	119	172	244	294
D, mm	41	42	42	42	42	57	57	57	57	57
E, mm	30	30	30	30	30	43	43	43	43	43
F, mm	25	26	26	26	26	38	38	38	38	38
H, mm	19	19	19	19	19	17	19	19	21	21
J, mm	-	25	25	25	25	-	35	35	35	35
K, mm	-	5	5	5	5	3	6	6	6	6
O, mm	-	M20 x 2	M20 x 2	M20 x 2	M20 x 2	-	M27 x 2	M27 x 2	M27 x 2	M27 x 2
P, mm	-	13	13	13	13	-	17	17	22	22
S, mm	-	-	-	-	-	-	-	-	-	-
U, mm	28.5	28	28	28	28	35	35	35	35	35
V, mm	2 x 5.5 ϕ	2 x M6	2 x M6	2 x M6	2 x M6	2 x M8	2 x M8	2 x M8	2 x M8	2 x M8
W, mm	-	23	23	23	23	27	27	27	27	27
X, mm	-	M42 x 1.5	M42 x 1.5	M42 x 1.5	M42 x 1.5	M57 x 1.5	M57 x 1.5	M57 x 1.5	M57 x 1.5	M57 x 1.5
Z, °	5	5	5	5	5	5	5	5	-	-

Model	YS-10/250	YS-10/300	YS-15/25	YS-15/50	YS-15/100	YS-15/150	YS-15/200	YS-15/250	YS-15/300	YS-15/350
A, mm	352	407	110	140	190	260	310	365	420	472
B, mm	602	707	135	190	290	410	510	615	720	822
C, mm	346	401	103	133	183	253	303	358	413	465
D, mm	57	57	67	67	67	67	67	67	67	67
E, mm	43	43	52	52	52	52	52	52	52	52
F, mm	38	38	46	46	46	46	46	46	46	46
H, mm	21	21	19	19	19	22	22	22	22	22
J, mm	35	35	40	40	40	40	40	40	40	40
K, mm	6	6	7	7	7	7	7	7	7	7
O, mm	M27 x 2	M27 x 2	M33 x 2	M33 x 2	M33 x 2	M33 x 2	M33 x 2	M33 x 2	M33 x 2	M33 x 2
P, mm	22	22	19	19	19	25	25	25	25	25
S, mm	-	-	-	-	-	-	-	-	-	-
U, mm	35	35	42	42	42	42	42	42	42	42
V, mm	2 x M8	2 x M8	2 x M10	2 x M10	2 x M10	2 x M10	2 x M10	2 x M10	2 x M10	2 x M10
W, mm	27	27	33	33	33	33	33	33	33	33
X, mm	M57 x 1.5	M57 x 1.5	M67 x 1.5	M67 x 1.5	M67 x 1.5	M67 x 1.5	M67 x 1.5	M67 x 1.5	M67 x 1.5	M67 x 1.5
Z, °	-	-	5	5	5	-	-	-	-	-

Model	YS-23/25	YS-23/50	YS-23/100	YS-23/160	YS-23/210	YS-23/250	YS-23/300	YS-23/345	YS-30/125	YS-30/200
A, mm	116	150	202	277	330	376	428	477	245	325
B, mm	141	200	302	437	540	626	728	822	370	525
C, mm	113	142	194	269	322	368	420	469	235	315
D, mm	85	85	85	85	85	85	85	85	102	102
E, mm	65	65	65	65	65	65	65	65	75	75
F, mm	56	56	56	56	56	56	56	56	65	65
H, mm	20	22	22	22	22	22	22	22	25	25
J, mm	50	50	50	50	50	50	50	50	50	50
K, mm	3	8	8	8	8	8	8	8	10	10
O, mm	M40 x 2	M40 x 2	M40 x 2	M40 x 2	M40 x 2	M40 x 2	M40 x 2	M40 x 2	M36 x 2	M36 x 2
P, mm	15	22	22	25	25	25	25	25	25	25
S, mm	-	-	-	-	-	-	-	-	-	-
U, mm	55	55	55	55	55	55	55	55	75	75
V, mm	4 x M10	4 x M10	4 x M10	4 x M10	4 x M10	4 x M10	4 x M10	4 x M10	4 x M10	4 x M10
W, mm	40	40	40	40	40	40	40	40	45	45
X, mm	M85 x 2	M85 x 2	M85 x 2	M85 x 2	M85 x 2	M85 x 2	M85 x 2	M85 x 2	M102 x 2	M102 x 2
Z, °	5	-	-	-	-	-	-	-	-	-

Dimensions model YS

Model	YS-50/50	YS-50/100	YS-50/160	YS-50/320	YS-70/150	YS-70/330	YS-100/100	YS-100/200
A, mm	170	220	285	460	285	490	275	375
B, mm	220	320	445	780	435	820	375	575
C, mm	165	215	280	455	280	485	270	370
D, mm	125	125	125	125	146	146	180	180
E, mm	95	95	95	95	112	112	135	135
F, mm	85	85	85	85	95	95	115	115
H, mm	29	29	29	29	30	30	60	60
J, mm	70	70	70	70	80	80	100	100
K, mm	5	5	5	5	5	5	5	5
O, mm	4 x M8	4 x M8	4 x M8	4 x M8	4 x M8	4 x M8	4 x M10	4 x M10
P, mm	-	-	-	-	-	-	-	-
S, mm	-	51	51	24	24	24	24	24
U, mm	95	95	95	95	110	110	145	145
V, mm	4 x M12	4 x M12	4 x M12	4 x M12	4 x M12	4 x M12	4 x M12	4 x M12
W, mm	50	50	50	50	60	60	70	70
X, mm	M125 x 2	M125 x 2	M125 x 2	M125 x 2	M146 x 3	M146 x 3	M180 x 3	M180 x 3
Z, °	-	-	-	-	-	-	-	-

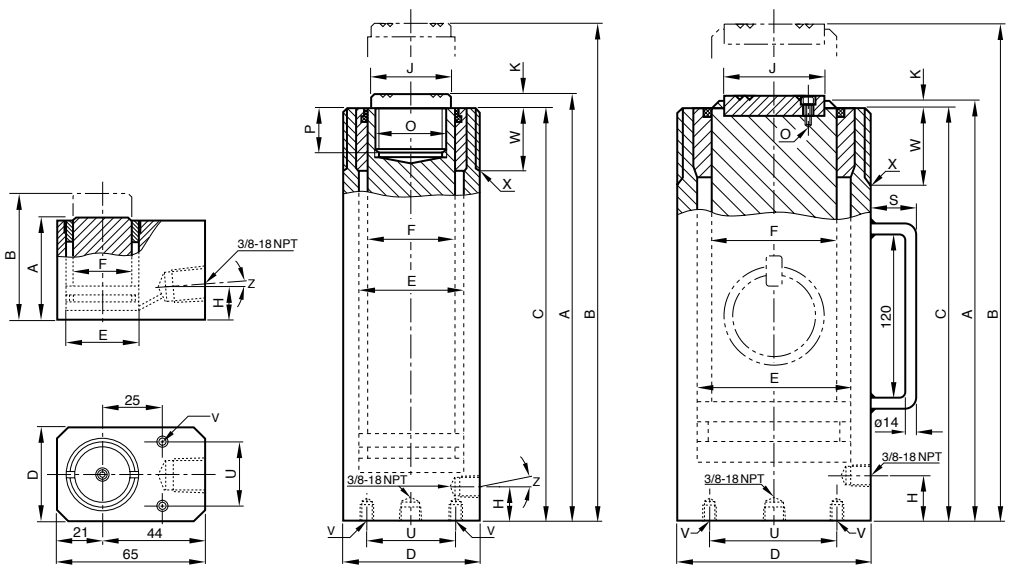

Model YS-5/15

Model YS-5/25 up to YS-30/200

Model YS-50/50 up to YS-100/200

Subject to changes.

Low-height and flat cylinders model YLS and model YFS

Single-acting with spring return,
10 -100 t

Low height cylinders are recommended for all lifting, pushing, levelling, pressing applications especially in tight working areas.

These very compact hydraulic cylinders are designed for lifting and positioning jobs as well as all general maintenance applications, where low height, portability and light weight are needed. These versatile cylinders are found in all industrial areas like steel mills, civil engineering, heavy construction industry, power plants, off-shore industries etc.

Low height cylinders are recommended for all lifting, pushing, levelling, pressing applications especially in tight working areas. Due to their short strokes flat cylinders should not be subjected to side loading.



YLS

! A selection chart "cylinder/hand pumps" can be found on pages 261 to 263.

Features

- Yale ChroMo-Design.
- Operating pressure max. 700 bar.
- Single-acting with spring return.
- Low height for tight working areas.
- Cylinder body and piston are made from massive chromium-molybdenum steel and heat treated.
- Stop ring can bear full capacity (pressure) and is fitted with dirt wiper.
- Oil port thread: 3/8 NPT.
- Incl. female coupler half model CFY-1.
- Model YLS-100/55 is equipped with two lifting rings model YFS-100/15 comes with a carrying handle.



YFS

Technical data model YLS

Cylinder size	Model	EAN-No. 4025092*	Max. capacity	Lift	Effective plunger area	Oil volume max.	Closed height	Cylinder outside diameter	Weight
t			kN	mm	cm ²	cm ³	mm	mm	kg
10	YLS-10/35	*150804	100	35	14.3	51	86	70	2.5
20	YLS-20/45	*150811	200	45	28.6	128	100	85	4.0
30	YLS-30/60	*150828	300	60	42.9	266	120	100	6.5
50	YLS-50/60	*150835	500	60	71.5	426	122	125	10.4
100	YLS-100/55	*150842	1000	55	143.0	788	141	170	24.0

Technical data model YFS

Cylinder size	Model	EAN-No. 4025092*	Max. capacity	Lift	Effective plunger area	Oil volume max.	Closed height	Cylinder outside diameter	Weight
t			kN	mm	cm ²	cm ³	mm	mm	kg
10	YFS-10/11	*150750	100	11	14.3	16	43	56	1.5
20	YFS-20/15	*150767	200	15	28.6	31	60	76	3.0
30	YFS-30/15	*150774	300	15	44.2	66	60	96	4.2
50	YFS-50/15	*150781	500	15	71.5	107	70	145	8.7
100	YFS-100/15	*150798	1000	15	143.0	215	91	170	16.0

Dimensions model YLS and model YFS

Model	YLS-10/35	YLS-20/45	YLS-30/60	YLS-50/60	YLS-100/55	YFS-10/11	YFS-20/15	YFS-30/15	YFS-50/15	YFS-100/15
A, mm	86	100	120	122	141	43	60	60	70	91
B, mm	121	145	180	182	196	54	75	75	85	106
D, mm	70	85	100	125	170	56	76	96	145	170
D1, mm	-	-	-	-	-	83	95	115	-	-
E, mm	43	60	75	95	135	43	60	75	95	135
F, mm	38	50	57	75	120	38	50	57	75	120
H, mm	16	17	19	19	26	16	19	19	19	22
M, mm	-	-	-	-	148	-	-	-	-	85
Q, mm	-	-	-	-	-	28	38	48	-	-
R, mm	54	54	54	54	54	54	54	54	54	54
S, mm	-	-	-	-	25	-	-	-	-	55
Z, °	10	10	5	5	-	10	5	5	5	-

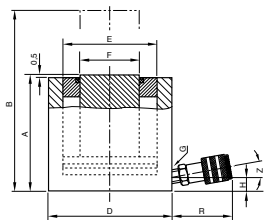

Model YLS

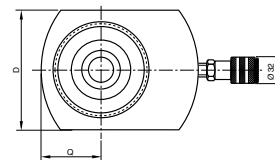
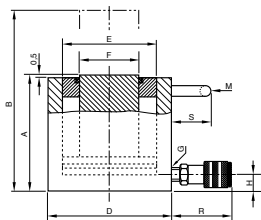

Model YFS

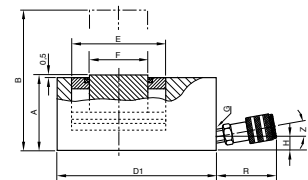



Pull cylinder model YPL

Single-acting with spring return,
capacity 10 - 51 t

Yale pull cylinders are able to create extremely high pulling forces and can be controlled precisely by the use of hand pumps or power packs. In neutral position pull cylinders are fully extended. As soon as the cylinders are pressurized the forged links are drawn together. A built-in return spring extends the piston again as soon as the pressure is released.

Shipbuilding, heavy vessel construction, steel construction, civil engineering as well as general repair and maintenance applications.

Features

- Yale ChroMo-Design.
- Operating pressure max. 700 bar.
- Single-acting with spring return.
- Can be operated in all positions (except model YPPS).
- Cylinder body and piston are made from massive chromium-molybdenum steel and heat treated.
- Hard-chromium plated piston with replaceable, heat treated saddle.
- Stop ring can bear full capacity (pressure) and is fitted with dirt wiper.
- Forged, replaceable links.
- With carrying handle and piston protection cover.
- Oil port thread: 3/8 NPT.
- Incl. female coupler half model CFY-1.
- The pull cylinder model YPPS-10/150 is equipped with an integrated hand pump similar to model HPS-2/0.7 A.

! A selection chart "cylinder/hand pumps" can be found on pages 261 to 263.

! A travel-speed chart is supplied on pages 264 to 265.

Technical data model YPL

Cylinder size	Model	EAN-No. 4025092*	Pulling force max. kN	Lift mm	Effective plunger area cm ²	Oil volume max. cm ³	Length between links mm	Weight kg
t								
10	YPL-10/150	*152822	100	150	14.2	213	750	9
20	YPL-20/150	*152839	200	150	30.6	459	795	22
30	YPL-30/150	*152846	300	150	42.6	639	875	29
51	YPL-51/150	*157858	510	150	74.6	1120	955	59
10	YPPS-10/150	*152853	100	150	14.2	213	750	19

Dimensions model YPL

Model	YPL-10/150	YPL-20/150	YPL-30/150	YPL-51/150	YPPS-10/150
A, mm	749	795	875	955	749
B, mm	78	95	120	150	78
C, mm	32	35	56	70	32
D, mm	68	105	121	156	68
E, mm	120	120	150	150	120
G, mm	23	30	32	40	23
H, mm	M24 x 1.5	M45 x 2	M50 x 2	M60 x 2	M24 x 1.5

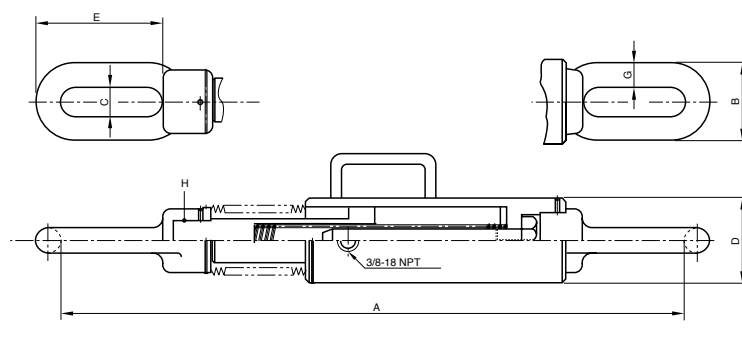

Model YPL



! A selection chart "cylinder/hand pumps" can be found on pages 261 to 263.

Hollow cylinders model YCS

Single-acting with spring return, 12 - 93 t

Due to the centre hole design a threaded rod can be placed through the hollow cylinders so that extremely high pulling forces can be achieved.

Hollow cylinders are used as the power component within hydraulic puller sets, for prestressing of anker bolts, removing of axles, shafts, bushings, extracting of tubes, as well as for heavy duty pulling applications.

Features

- Yale ChroMo-Design.
- Operating pressure max. 700 bar.
- Single-acting with spring return.
- With large centre hole diameter.
- Cylinder body and piston are made from massive chromium-molybdenum steel and heat treated.
- Hard-chromium plated piston with replaceable, heat treated saddle.
- Metric mounting threads at cylinder body and inside of piston.
- Stop ring prevents overtravel of the piston up to full operating pressure.
- Interchangeable hardened saddle.
- With inner and outer dirt wipers.
- Oil port thread: 3/8 NPT.
- Incl. female coupler half model CFY-1.
- From model YCS-21/150 with carrying handle.
- From model YCS-57/70 with two lifting rings.

Function principal of the hollow cylinders

In connection with threaded rods hollow cylinders can create extremely high forces which are helpful for various repair or assembly applications like removing press-fitted parts, prestressing of anchors etc. In addition, hollow cylinders are used as power source in puller sets and test rigs. By the use of long threaded rods and by readjusting the nut larger distances can be pulled even by use of short cylinder strokes.



Technical data model YCS

Cylinder size t	Model	EAN-No. 4025092*	Capacity kN	Lift mm	Effective plunger area cm ²	Oil volume max. cm ³	Closed height mm	Centre hole diameter mm	Cylinder outside diameter mm	Weight kg
12	YCS-12/40	*150873	120	40	17.2	71	142	20	70	3.5
12	YCS-12/75	*150880	120	75	17.2	132	195	20	70	4.5
21	YCS-21/50	*150897	214	50	30.5	153	173	27	100	8.5
21	YCS-21/150	*150903	214	150	30.5	458	335	27	100	15.0
33	YCS-33/60	*150910	335	60	47.9	287	193	33	114	12.0
33	YCS-33/150	*150927	335	150	47.9	716	343	33	114	21.0
57	YCS-57/70	*150934	567	70	81.0	562	242	42	150	25.0
62	YCS-62/150	*150941	618	150	88.3	1330	335	55	163	38.0
93	YCS-93/75	*150958	930	75	133.0	990	280	80	214	55.0

Dimensions model YCS

Model	YCS-12/40	YCS-12/75	YCS-21/50	YCS-21/150	YCS-33/60	YCS-33/150	YCS-57/70	YCS-62/150	YCS-93/75
A, mm	135	188	163	325	183	333	230	323	265
B, mm	175	263	213	475	243	483	300	473	340
C, mm	20	20	27	27	33	33	42	55	80
D, mm	70	70	100	100	114	114	150	163	214
E, mm	55	55	73	73	90	90	118	130	170
F, mm	40	40	53	53	65	65	90	100	136
J, mm	38	38	50	50	62	62	85	96	132
K, mm	3	3	3	3	3	3	3	3	5
M, mm	-	-	-	120	-	120	-	-	-
O, mm	M30 x 1.5	M30 x 1.5	M40 x 1.5	M40 x 1.5	M48 x 1.5	M48 x 1.5	M65 x 2	M78 x 2	M115 x 2
P, mm	20	20	25	25	30	30	35	40	45
R, mm	4	4	5	5	5	5	5	5	-
S, mm	-	-	-	51	-	51	24	24	24
T, mm	-	-	-	-	-	-	155	200	170
U, mm	58	58	82	82	92	92	120	135	180
V, mm	2 x M8	2 x M8	2 x M10	2 x M10	4 x M10	4 x M10	4 x M12	4 x M12	4 x M16
W, mm	30	30	35	35	40	40	50	60	-
X, mm	M70 x 2	M70 x 2	M100 x 2	M100 x 2	M110 x 2	M110 x 2	M150 x 3	M160 x 3	-
Y, mm	7	7	10	10	10	10	12	12	15

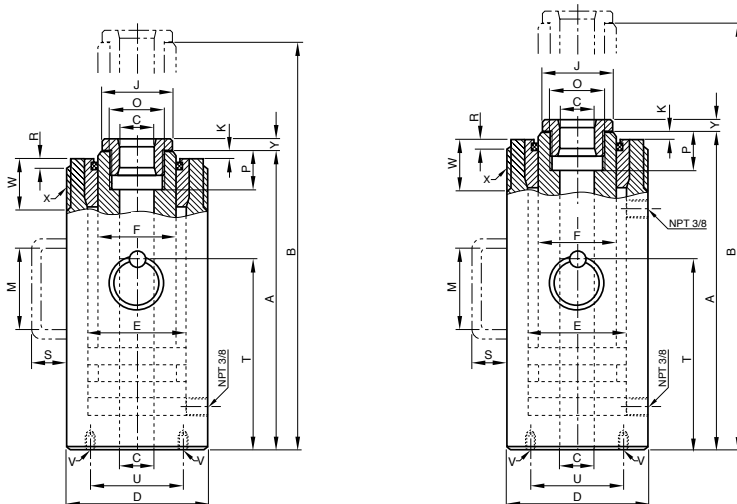

Model YCS



On request we supply special hollow cylinders with pulling capacities up to 600 tons.

Hollow cylinders model YCH

Double-acting with hydraulic return,
33 - 140 t

Basically the applications are the same as for the single-acting hollow cylinders shown on the opposite page but for this model range the return of the piston is done hydraulically by means of the second oil port. These double-acting hollow cylinders are used, when the piston needs to be retracted quickly e.g. with high-cycle pulling applications.

Features

- Yale ChroMo-Design.
- Operating pressure max. 700 bar.
- Double-acting with hydraulic return.
- With large centre hole diameter.
- Cylinder body and piston are made from massive chromium-molybdenum steel and heat treated.
- Hard-chromium plated piston with replaceable, heat treated saddle.
- Metric mounting threads at cylinder body and inside of piston.
- Stop ring prevents overtravel of the piston up to full operating pressure.
- Interchangeable hardened saddle.
- With inner and outer dirt wipers.
- Oil port thread: 3/8 NPT.
- Incl. 2 female coupler halves model CFY-1.
- All cylinders with carrying handle, from YCH-62/250 with 2 lifting rings.

A selection chart “cylinder/hand pumps” can be found on pages 261 to 263.

Technical data model YCH

Cylinder size	Model	EAN-No. 4025092*	Capacity push	Capacity pull	Lift	Effective plunger area	Oil volume max.	Closed height	Centre hole diameter	Cylinder outside diameter	Weight
t			kN	kN	mm	cm ²	cm ³	mm	mm	mm	kg
33	YCH-33/150	*150965	335	180	150	47.9	716	310	33	114	19
33	YCH-33/250	*150972	335	180	250	47.9	1200	415	33	114	25
62	YCH-62/250	*150989	618	300	250	88.3	2220	452	55	163	55
93	YCH-93/250	*150996	930	450	250	133.0	3320	465	55	193	82
100	YCH-100/40	*151009	1000	500	40	143.0	578	190	55	200	38
140	YCH-140/200	*151016	1400	700	200	200.2	4080	383	80	253	115

For double-acting hollow cylinders the "capacity push" is equivalent to the max. pulling force achieved with tensioning anchor or threaded spindle.

Dimensions model YCH

Model	YCH-33/150	YCH-33/250	YCH-62/250	YCH-93/250	YCH-100/40	YCH-140/200
A, mm	300	405	440	450	175	365
B, mm	450	655	690	700	215	565
C, mm	33	33	55	55	55	80
D, mm	114	114	163	193	200	253
E, mm	90	90	130	150	155	195
F, mm	67	67	105	120	125	160
J, mm	62	62	96	110	110	145
K, mm	3	3	5	5	5	5
M, mm	120	120	-	-	-	-
O, mm	M48 x 1.5	M48 x 1.5	M78 x 2	M85 x 2	M85 x 2	M115 x 2
P, mm	30	30	40	45	45	50
R, mm	5	5	5	5	-	-
S, mm	51	51	24	30	24	30
T, mm	-	-	290	290	115	240
U, mm	92	92	135	160	165	210
V, mm	4 x M10	4 x M10	4 x M12	4 x M16	4 x M16	4 x M16
W, mm	40	40	50	65	-	-
X, mm	M110 x 2	M110 x 2	M160 x 3	M190 x 3	-	-
Y, mm	10	10	12	15	15	18

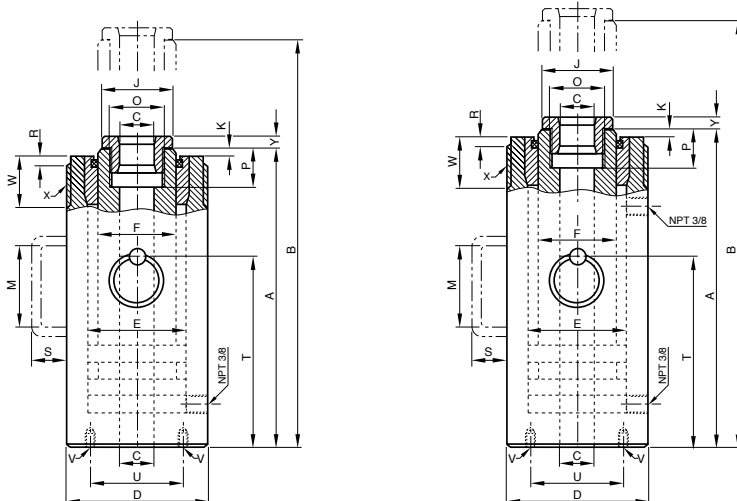

Model YCH



A selection chart "cylinder/hand pumps" can be found on pages 261 to 263.

Universal cylinders model YH

Double-acting with hydraulic return, 5 - 200 t

These extremely robust double-acting cylinders are especially designed for universal heavy duty lifting and positioning applications as well as for industrial production and assembly jobs. The cylinders offer high pushing and pulling forces. The double-acting design assures a high piston retraction speed.

Major areas of application are bridge building and civil engineering, off-shore, ship building, etc. They can also be used as power source in frame presses, stamping fixtures and other industrial uses where high pushing and pulling forces are required.

Features

- Yale ChroMo-Design.
- Operating pressure max. 700 bar.
- Double-acting with hydraulic return.
- Long bronze piston guidings.
- Piston strokes from 30 up to 500 mm.
- Cylinder body and piston are made from massive chromium-molybdenum steel and heat treated.
- Double bronze bearing of the hard chromium plated piston.
- Metric mounting threads on cylinder housing, in the bottom of the cylinder body and in the piston rod.
- Stop ring can bear full capacity (pressure) and is fitted with dirt wiper.
- Interchangeable hardened saddle.
- Dirt wiper protect against dirt.
- Oil port thread: 3/8 NPT.
- Incl. 2 female coupler halves model CFY-1.
- From YH-30/200 with carrying handle.
- From YH-50/350 with 2 lifting rings.

Technical data model YH

Cylinder size	Model	EAN-No. 4025092*	Capacity push	Capacity pull	Lift	Effective plunger area push cm ²	Effective plunger area pull cm ²	Oil volume max. cm ³	Closed height mm	Cylinder outside diameter mm	Weight kg
t			kN	kN	mm						
5	YH-5/30	*150408	50	22	30	7.2	3.1	21	160	55	2.5
5	YH-5/80	*150415	50	22	80	7.2	3.1	57	210	55	3.3
5	YH-5/150	*150422	50	22	150	7.2	3.1	106	280	55	4.4
10	YH-10/30	*150439	100	45	30	14.3	6.4	44	175	67	4.0
10	YH-10/80	*150446	100	45	80	14.3	6.4	116	225	67	5.0
10	YH-10/150	*150453	100	45	150	14.3	6.4	218	295	67	6.7
10	YH-10/250	*150460	100	45	250	14.3	6.4	363	395	67	9.0
20	YH-20/50	*150477	200	100	50	28.6	14.3	142	195	85	7.0
20	YH-20/150	*150484	200	100	150	28.6	14.3	424	310	85	11.0
20	YH-20/250	*150491	200	100	250	28.6	14.3	707	410	85	14.0
30	YH-30/200	*150507	300	140	200	42.9	20.0	884	355	102	19.0
30	YH-30/350	*150514	300	140	350	42.9	20.0	1547	510	102	27.0
50	YH-50/150	*150521	500	220	150	71.5	31.5	1064	325	125	27.0
50	YH-50/350	*150538	500	220	350	71.5	31.5	2481	525	125	42.0
50	YH-50/500	*150545	500	220	500	71.5	31.5	3544	685	125	52.0
70	YH-70/150	*150552	700	330	150	100.0	47.2	1478	335	146	37.0
70	YH-70/350	*150569	700	330	350	100.0	47.2	3449	540	146	56.0
100	YH-100/50	*150576	1000	450	50	143.0	64.4	716	265	180	49.0
100	YH-100/150	*150583	1000	450	150	143.0	64.4	2148	365	180	64.0
100	YH-100/350	*150590	1000	450	350	143.0	64.4	5010	565	180	94.0
100	YH-100/500	*150606	1000	450	500	143.0	64.4	7157	725	180	118.0
200	YH-200/150	*150613	2000	900	150	286.0	128.7	4253	410	250	137.0
200	YH-200/350	*150620	2000	900	350	286.0	128.7	9924	620	250	198.0
200	YH-200/500	*150637	2000	900	500	286.0	128.7	14177	780	250	244.0

For accessories for cylinders series YH please see pages 208 to 209.

Dimensions model YH

Model	YH-5/30	YH-5/80	YH-5/150	YH-10/30	YH-10/80	YH-10/150	YH-10/250	YH-20/50	YH-20/150	YH-20/250	YH-30/200	YH-30/350
A, mm	160	210	280	175	225	295	395	195	310	410	355	510
B, mm	190	290	430	205	305	445	645	245	460	660	555	860
C, mm	138	188	258	150	200	270	370	167	282	382	345	500
D, mm	55	55	55	67	67	67	67	85	85	85	102	102
E, mm	30	30	30	43	43	43	43	60	60	60	75	75
F, mm	22.4	22.4	22.4	32	32	32	32	42	42	42	55	55
H, mm	31	31	31	35	35	35	35	22	37	37	46	46
I, mm	44	44	44	50	50	50	50	59	59	59	64	64
J, mm	-	-	-	-	-	-	-	-	-	-	50	50
K, mm	4	4	4	5	5	5	5	5	5	5	10	10
L, mm	17	17	17	20	20	20	20	-	22	22	28	28
O, mm	M18 x 1.5	M18 x 1.5	M18 x 1.5	M27 x 2	M27 x 2	M27 x 2	M27 x 2	M36 x 2	M36 x 2	M36 x 2	M36 x 2	M36 x 2
P, mm	18	18	18	20	20	20	20	23	23	23	28	28
S, mm	-	-	-	-	-	-	-	-	-	-	51	51
U, mm	-	-	-	-	-	-	-	-	-	-	-	-
V, mm	M27 x 2	M27 x 2	M27 x 2	M36 x 2	M36 x 2	M36 x 2	M36 x 2	-	M45 x 2	M45 x 2	M36 x 2	M36 x 2
W, mm	27	27	27	33	33	33	33	40	40	40	45	45
X, mm	M55 x 1.5	M55 x 1.5	M55 x 1.5	M67 x 1.5	M67 x 1.5	M67 x 1.5	M67 x 1.5	M85 x 2	M85 x 2	M85 x 2	M102 x 2	M102 x 2

Model	YH-50/150	YH-50/350	YH-50/500	YH-70/150	YH-70/350	YH-100/50	YH-100/150	YH-100/350	YH-100/500	YH-200/150	YH-200/350	YH-200/500
A, mm	325	525	685	335	540	265	365	565	725	410	620	780
B, mm	475	875	1185	485	890	315	515	915	1225	560	970	1280
C, mm	313	513	673	321	526	250	350	550	710	391	601	761
D, mm	125	125	125	146	146	180	180	180	180	250	250	250
E, mm	95	95	95	112	112	135	135	135	135	190	190	190
F, mm	70	70	70	80	80	100	100	100	100	140	140	140
H, mm	55	55	55	58	58	66	66	66	66	80	80	80
I, mm	70	70	70	79	79	90	90	90	95	105	105	105
J, mm	65	65	65	75	75	90	90	90	90	127	127	127
K, mm	12	12	12	14	14	15	15	15	15	19	19	19
L, mm	31	31	31	35	35	-	-	-	-	-	-	-
O, mm	M45 x 2	M45 x 2	M45 x 2	M50 x 3	M50 x 3	M65 x 3	M65 x 3	M65 x 3	M65 x 3	M90 x 3	M90 x 3	M90 x 3
P, mm	31	31	31	35	35	40	40	40	40	55	55	55
S, mm	51	24	24	24	24	24	24	30	30	30	30	30
U, mm	-	-	-	-	-	110	110	110	110	160	160	160
V, mm	M45 x 2	M45 x 2	M45 x 2	M50x3	M50x3	4 x M12	4 x M12	4 x M12	4 x M12	4 x M16	4 x M16	4 x M16
W, mm	50	50	50	60	60	70	70	70	70	80	80	80
X, mm	M125 x 2	M125 x 2	M125 x 2	M146 x 3	M146 x 3	M180 x 3	M180 x 3	M180 x 3	M180 x 3	M250 x 4	M250 x 4	M250 x 4

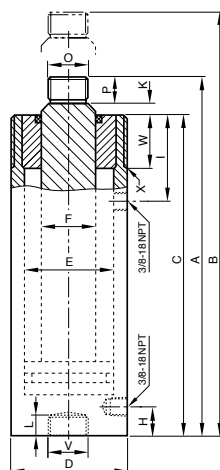

Model YH-5/30 up to YH 20/250

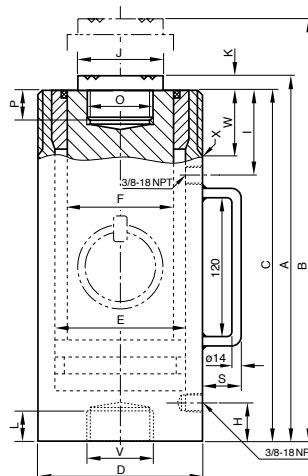

Model YH-30/200 up to YH 70/350

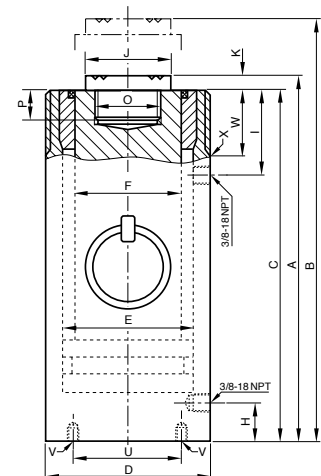

Model YH-100/50 up to YH 200/500

Hydraulic Jacks & Tools



High tonnage cylinders model YEHA

Double-acting with hydraulic return,
140 - 1100 t

Cylinders of series YEHA are normally used for lifting, positioning or handling of heavy loads. The double-acting function allows a faster piston return, even with longer hydraulic hoses.

Lifting and moving of large machinery, steel construction, bridges or similar loads, supporting of buildings and foundations.

Further applications are positioning, weighing, through pressing, stress testing or jacking of all kinds of loads.

Features

- Operating pressure max. 700 bar.
- Double-acting with hydraulic return.
- Generous guiding bands ensure a robust piston guiding.
- Hard chromium-plated piston.
- Stop ring as piston end stop.
- Interchangeable hardened saddle.
- Dirt wiper protect against dirt.
- Oil port thread: 3/8 NPT.
- Incl. 2 female coupler halves model CFY-1.
- Mounting threads on request.
- All cylinders have lifting rings.



! A travel-speed chart is supplied
on pages 264 to 265.

Technical data model YEHA

Cylinder size	Model	EAN-No. 4025092*	Capacity max.	Lift	Effective plunger area	Oil volume max.	Closed height	Cylinder outside diameter	Weight
t			kN	mm	cm ²	cm ³	mm	mm	kg
140	YEHA-140/50	*162937	1400	50	201	1005	201	200	44
140	YEHA-140/100	*162920	1400	100	201	2010	251	200	51
140	YEHA-140/150	*162944	1400	150	201	3015	306	200	59
140	YEHA-140/200	*162951	1400	200	201	4020	356	200	66
140	YEHA-140/300	*162975	1400	300	201	6030	461	200	81
220	YEHA-220/50	*162982	2200	50	314	1570	216	250	75
220	YEHA-220/100	*162999	2200	100	314	3140	266	250	86
220	YEHA-220/150	*163002	2200	150	314	4710	326	250	101
220	YEHA-220/300	*163033	2200	300	314	9425	486	250	139
340	YEHA-340/50	*163125	3430	50	491	2453	231	310	127
340	YEHA-340/100	*163132	3430	100	491	4906	281	310	148
340	YEHA-340/150	*163149	3430	150	491	7360	341	310	175
340	YEHA-340/300	*163170	3430	300	491	14700	501	310	243
430	YEHA-430/50	-	4226	50	616	3079	248	340	164
430	YEHA-430/100	-	4226	100	616	6158	294	340	188
430	YEHA-430/150	-	4226	150	616	9236	353	340	215
430	YEHA-430/250	-	4226	300	616	18474	508	340	293
560	YEHA-560/50	-	5620	50	804	4019	268	390	234
560	YEHA-560/100	*163446	5620	100	804	8038	318	390	286
560	YEHA-560/150	*163439	5620	150	804	12058	373	390	301
560	YEHA-560/300	-	5620	300	804	24130	538	390	406
670	YEHA-670/50	-	6603	50	962	4811	283	430	304
670	YEHA-670/100	-	6603	100	962	9621	333	430	343
670	YEHA-670/150	-	6603	150	962	14432	398	430	400
670	YEHA-670/300	-	6603	300	962	28866	558	430	529
880	YEHA-880/50	-	8790	50	1257	6280	310	490	434
880	YEHA-880/100	-	8790	100	1257	12560	360	490	485
880	YEHA-880/150	-	8790	150	1257	18840	420	490	551
880	YEHA-880/300	-	8790	300	1257	37700	580	490	719
1100	YEHA-1100/50	-	11000	50	1590	7949	330	550	584
1100	YEHA-1100/100	-	11000	100	1590	15896	380	550	648
1100	YEHA-1100/150	-	11000	150	1590	23845	440	550	731
1100	YEHA-1100/300	-	11000	300	1590	47700	600	550	943

For tilt saddles for cylinders please see pages 204 to 205.

Hydraulic cylinders with safety lock nut model YEL

Single-acting, 30 - 1100 t

Hydraulic cylinders with safety lock nut are recommended when loads have to remain in the lifted position over a period of time. The safety lock nut ensures a positive load hold in any position and work can be carried out beneath the lifted load. Hydraulic pressure can be released so that cylinders work like mechanical supports. Pumps can be separated from cylinders.

Lifting and moving of large machinery, steel construction, bridges or similar loads, supporting of buildings and foundations.

For all heavy duty jacking applications where a special safety factor is appropriate like lifting and lowering of bridges, supporting of buildings and foundations, jacking up of heavy machines, steel sections, ship modules or similar loads.

Features

- Operating pressure max. 700 bar.
- Single-acting with gravity return.
- Generous guiding bands ensure a robust piston guiding.
- Hard chromium-plated piston with trapezoid thread.
- Over-flow hole ensures a definite piston end stop.
- Interchangeable hardened saddle.
- Oil port thread: 3/8 NPT.
- Incl. female coupler half model CFY-1.
- All cylinders have lifting rings.



A travel-speed chart is supplied on pages 264 to 265.



Model YEL

For tilt saddles for cylinders please see pages 204 to 205.

Hydraulic Jacks & Tools Hydraulic cylinders, single-acting

Technical data model YEL

Cylinder size	Model	EAN-No. 4025092*	Capacity max.	Lift	Effective plunger area	Oil volume max.	Closed height	Cylinder outside diameter	Weight
t			kN	mm	cm ²	cm ³	mm	mm	kg
30	YEL-30/50	*151894	300	50	44.2	221	169	100	10.5
30	YEL-30/100	*151900	300	100	44.2	442	219	100	13.5
30	YEL-30/150	*151917	300	150	44.2	663	269	100	17.5
30	YEL-30/200	-	300	200	44.2	885	319	100	19.5
30	YEL-30/300	*162074	300	300	44.2	1325	419	100	26.0
50	YEL-50/50	*151924	486	50	70.8	355	185	125	17.5
50	YEL-50/100	*151931	486	100	70.8	710	235	125	22.0
50	YEL-50/150	*151948	486	150	70.8	1063	285	125	30.0
50	YEL-50/200	-	486	200	70.8	1420	335	125	32.0
50	YEL-50/300	-	486	300	70.8	2130	435	125	41.0
100	YEL-93/50	*151955	931	50	133	663	200	180	40.0
100	YEL-93/100	*151962	931	100	133	1327	250	180	48.5
100	YEL-93/150	*151979	931	150	133	1989	300	180	58.5
100	YEL-93/200	*163637	931	200	133	2654	350	180	68.5
100	YEL-93/300	-	931	300	133	3980	450	180	83.5
140	YEL-140/50	*151986	1400	50	201	1005	211	215	60.0
140	YEL-140/100	*151993	1400	100	201	2010	259	215	72.5
140	YEL-140/150	*152006	1400	150	201	3015	309	215	88.0
140	YEL-140/200	*040327	1400	200	201	4020	359	215	102.0
140	YEL-140/300	-	1400	300	201	6030	459	215	130.0
220	YEL-220/50	*152013	2200	50	314	1570	245	265	105.0
220	YEL-220/100	*152020	2200	100	314	3140	295	265	148.0
220	YEL-220/150	*152037	2200	150	314	4710	395	265	189.0
220	YEL-220/250	*163545	2200	250	314	7850	445	265	213.0
340	YEL-340/50	*163965	3370	50	491	2453	275	330	183.0
340	YEL-340/100	*055536	3370	100	491	4906	345	330	229.0
340	YEL-340/150	*162418	3370	150	491	7360	395	330	263.0
340	YEL-340/250	-	3370	250	491	12300	495	330	329.0
430	YEL-430/50	*152051	4226	50	615	3078	335	380	296.0
430	YEL-430/100	*152068	4226	100	615	6157	385	380	340.0
430	YEL-430/150	*152075	4226	150	615	9232	435	380	385.0
430	YEL-430/250	-	4226	250	615	15400	535	380	473.0
560	YEL-560/50	-	5520	50	804	4019	375	430	390.0
560	YEL-560/100	-	5520	100	804	8038	425	430	481.0
560	YEL-560/150	*161350	5520	150	804	12058	475	430	537.0
560	YEL-560/250	-	5520	250	804	20100	575	430	650.0
670	YEL-670/50	-	6603	50	961	4809	395	475	545.0
670	YEL-670/100	-	6603	100	961	9621	445	475	614.0
670	YEL-670/150	-	6603	150	961	14425	495	475	683.0
670	YEL-670/250	-	6603	250	961	24100	595	475	821.0
880	YEL-880/50	-	8625	50	1256	6280	455	540	714.0
880	YEL-880/100	-	8625	100	1256	12560	505	540	901.0
880	YEL-880/150	-	8625	150	1256	18840	555	540	1008.0
880	YEL-880/250	-	8625	250	1256	31400	655	540	1170.0
1100	YEL-1100/50	-	10916	50	1590	7949	500	600	969.0
1100	YEL-1100/100	-	10916	100	1590	15896	550	600	1201.0
1100	YEL-1100/150	-	10916	150	1590	23845	600	600	1310.0
1100	YEL-1100/250	-	10916	250	1590	39741	700	600	1530.0

Further piston strokes are quoted on request.



A travel-speed chart is supplied on pages 264 to 265.

High tonnage cylinders model YEGA

Single-acting, 140 - 1100 t

These inexpensive cylinders of series YEGA are used for all general lifting applications in any area of industry where heavy loads need to be lifted, lowered, levelled, positioned or supported.

Lifting and moving of large machinery, steel construction, bridges or similar loads, supporting of buildings and foundations.

For all heavy duty jacking applications where a special safety factor is appropriate like lifting and lowering of bridges, supporting of buildings and foundations, jacking up of heavy machines, steel sections, ship modules or similar loads.

Features

- Operating pressure max. 700 bar.
- Plunger in special piston guiding bands.
- Hard chromium-plated piston.
- Over-flow hole ensures a definite piston end stop.
- Interchangeable hardened saddle.
- Oil port thread: 3/8 NPT.
- Incl. female coupler half model CFY-1.
- All cylinders have lifting rings.

The use of tilt saddles is recommended.



Tilt saddles for cylinders model AYL

Tilt saddles should be used with YEL and YEGA cylinders in cases where cylinders are operated on non-parallel surfaces.

The saddles minimize inner friction caused by eccentric loading of the cylinders. The upper part of the saddle can pivot up to 5° in all directions. Tilt saddles are fixed in the piston by means of an o-ring.

Deliverable for all cylinders up to 1100 t. Also available for the cylinder series YS.

Technical data model YEGA

Cylinder size	Model	EAN-No. 4025092*	Capacity max.	Lift	Effective plunger area	Oil volume max.	Closed height	Cylinder outside diameter	Weight
t			kN	mm	cm ²	cm ³	mm	mm	kg
140	YEGA-140/50	*163385	1380	50	201	1005	155	200	38
140	YEGA-140/100	*163194	1380	100	201	2010	205	200	51
140	YEGA-140/150	*163200	1380	150	201	3015	255	200	63
140	YEGA-140/200	*163217	1380	200	201	4020	305	200	75
140	YEGA-140/300	*163231	1380	300	201	6030	405	200	100
220	YEGA-220/50	*163248	2200	50	314	1570	170	250	64
220	YEGA-220/100	*163255	2200	100	314	3140	220	250	85
220	YEGA-220/150	*163262	2200	150	314	4710	270	250	104
220	YEGA-220/250	*163286	2200	250	314	7850	370	250	143
340	YEGA-340/50	*163309	3370	50	491	2453	210	310	123
340	YEGA-340/100	*163319	3370	100	491	4906	260	310	154
340	YEGA-340/150	*163323	3370	150	491	7360	310	310	184
340	YEGA-340/250	*163347	3370	250	491	12300	410	310	243
430	YEGA-430/50	*163484	4226	50	616	3079	215	340	125
430	YEGA-430/100	*163491	4226	100	616	6158	265	340	157
430	YEGA-430/150	*163507	4226	150	616	9236	315	340	190
430	YEGA-430/250	*163927	4226	250	616	15394	415	340	255
560	YEGA-560/50	-	5520	50	804	4019	240	390	223
560	YEGA-560/100	-	5520	100	804	8038	290	390	272
560	YEGA-560/150	-	5520	150	804	12058	340	390	319
560	YEGA-560/250	-	5520	250	804	20100	440	390	413
670	YEGA-670/50	-	6603	50	962	4811	265	430	298
670	YEGA-670/100	-	6603	100	962	9621	315	430	355
670	YEGA-670/150	-	6603	150	962	14432	365	430	412
670	YEGA-670/250	-	6603	250	962	24053	465	430	525
880	YEGA-880/50	-	8625	50	1257	6280	290	490	423
880	YEGA-880/100	-	8625	100	1257	12560	340	490	503
880	YEGA-880/150	-	8625	150	1257	18840	390	490	577
880	YEGA-880/250	-	8625	250	1257	31400	490	490	725
1100	YEGA-1100/50	*163569	10916	50	1590	7949	415	550	766
1100	YEGA-1100/100	*163576	10916	100	1590	15896	465	550	867
1100	YEGA-1100/150	-	10916	150	1590	23845	515	550	960
1100	YEGA-1100/250	*163743	10916	250	1590	39741	615	550	1147

Further piston strokes are quoted on request.

Technical data model AYL

Model	EAN-No. 4025092*	Suitable for cylinder groups	Weight kg
AYL-30	*156837	YEL-30...	0.4
AYL-50	*156844	YEL-50...	0.8
AYL-100	*156851	YEL-93...	2.0
AYL-150	*156868	YEL-140... and YEGA-140...	3.4
AYL-200	*156875	YEL-220... and YEGA-220...	5.8
AYL-340	-	YEL-340... and YEGA-340...	13.0
AYL-430	-	YEL-340... and YEGA-340...	19.5

Dimensions model AYL

Model	AYL-30	AYL-50	AYL-100	AYL-150	AYL-200	AYL-340	AYL-430
A, mm	45	61	88	111	131	178	200
B, mm	36	39	47	52	57	67	79
C, mm	28	30	36	40	45	47	57

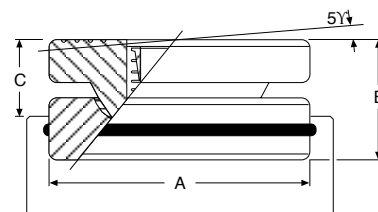



Lifting claws, piston plates, base adaptors and extension tubes, load spreading plates model AYS

Lifting claws

In connection with the corresponding hydraulic cylinder a lifting claw represents a compact, lightweight and versatile lifting unit. The lifting claws are screwed onto the collar thread of the cylinder series YS. Claws can be placed under loads with minimum clearance.

By operating lifting claws, the following aspects have to be considered:

The hydraulic cylinders need to be able to support themselves against the load. The max. force of the cylinder is reduced by 50 %.

Piston plates

Piston plates can be screwed into the piston thread of cylinders series YS. They reduce the surface pressure and prevent the pistons from sinking into the ground. Also when using a piston plate in connection with a lifting claw the cylinder must be supported against the load.

Base adaptors and extension tubes

Extension tubes are mounted onto the bottom of cylinders series YS by means of the base adaptor and two hexagon socket screws (screws are included with the base adaptor).

The use of extension tubes adds to the versatility of the standard cylinders.

Load spreading plates

These load spreading plates are recommended when slim cylinders are used for lifting operations. They protect the cylinders from falling over and sinking into the ground.

Robust steel design with carrying handle.



AYS-101
151
231



Straightening of a container box by use of a hydraulic cylinder YS-10/150, extension tube AYS-106, base adaptor AYS-103 and electric power pump PY-04/2/5/2 M.



Lifting of a container by use of an hydraulic cylinder YS-23/160, lifting claw AYS-23 and piston plate AYS-232 powered by a two-stage hand pump HPS-2/2 with base frame HPB-2.

Technical data model AYS

Model	EAN-No. 4025092*	Description	Suitable for cylinder	Weight kg
AYS-10	*156721	Lifting claw, acceptable capacity 5 t	YS-10/...	0.9
AYS-15	*156738	Lifting claw, acceptable capacity 8 t	YS-15/...	1.3
AYS-23	*156745	Lifting claw, acceptable capacity 12 t	YS-23/...	3.8
AYS-53	*157049	Base adaptor, 5 t	YS-5/...	0.5
AYS-54	*157056	Extension tube 125 mm, 5 t	YS-5/...	0.9
AYS-55	*157063	Extension tube 250 mm, 5 t	YS-5/...	1.5
AYS-56	*157070	Extension tube 500 mm, 5 t	YS-5/...	2.8
AYS-101	*157100	Load spreading plate 10 t	YS-10/...	10.5
AYS-102	*156752	Piston plate, round	YS-10/...	1.5
AYS-103	*156783	Base adaptor, 10 t	YS-10/...	0.7
AYS-104	*156790	Extension tube 125 mm, 10 t	YS-10/...	1.2
AYS-105	*156806	Extension tube 250 mm, 10 t	YS-10/...	2.2
AYS-106	*156813	Extension tube 500 mm, 10 t	YS-10/...	3.9
AYS-107	*156820	Extension tube 750 mm, 10 t	YS-10/...	5.9
AYS-151	*157131	Load spreading plate 15 t	YS-15/...	10.5
AYS-152	*156769	Piston plate, round	YS-15/...	1.8
AYS-153	*156929	Base adaptor, 15 t	YS-15/...	0.9
AYS-154	*156936	Extension tube 125 mm, 15 t	YS-15/...	1.6
AYS-155	*156943	Extension tube 250 mm, 15 t	YS-15/...	2.9
AYS-156	*156950	Extension tube 500 mm, 15 t	YS-15/...	4.9
AYS-157	*156967	Extension tube 750 mm, 15 t	YS-15/...	7.9
AYS-231	*157162	Load spreading plate 23 t	YS-23/...	10.5
AYS-232	*156776	Piston plate, round	YS-23/...	2.2

Dimensions model AYS

Model	AYS-10	AYS-15	AYS-23	AYS-53	AYS-54	AYS-55	AYS-56	AYS-101	AYS-102	AYS-103	AYS-104	AYS-105
A, mm	90	110	125	53	125	250	500	230	140	58	125	250
B, mm	90	110	125	50	-	-	-	120	12	60	-	-
C, mm	30	30	30	-	-	-	-	58	-	-	-	-
D, mm	29	34	40	-	-	-	-	-	-	-	-	-
E, mm	22	25	35	-	-	-	-	-	-	-	-	-
F, mm	M57 x 1.5	M67 x 1.5	M85 x 2	M42 x 1.5	M42 x 1.5	M42 x 1.5	M42 x 1.5	-	M27 x 2	M50 x 2	M50 x 2	M50 x 2

Model	AYS-106	AYS-107	AYS-151	AYS-152	AYS-153	AYS-154	AYS-155	AYS-156	AYS-157	AYS-231	AYS-232
A, mm	500	750	230	140	70	125	250	500	750	230	160
B, mm	-	-	120	12	73	-	-	-	-	120	15
C, mm	-	-	68	-	-	-	-	-	-	86	-
D, mm	-	-	-	-	-	-	-	-	-	-	-
E, mm	-	-	-	-	-	-	-	-	-	-	-
F, mm	M50 x 2	M50 x 2	-	M33 x 2	M60 x 2	M60 x 2	M60 x 2	M60 x 2	M60 x 2	-	M40 x 2

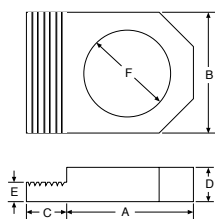

Lifting claws

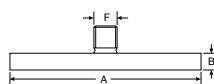

Piston plates



Base adaptors

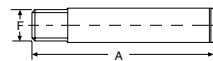

Extension tubes

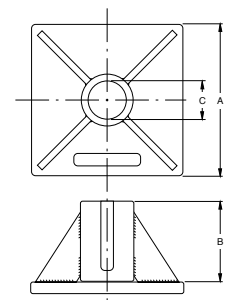

Load spreading plates



Threaded flanges model AYP

In case hydraulic cylinders have to be inserted into fixtures, press frames or similar devices, these steel flanges can be very handy. Material: weldable steel.

Technical data model AYP

Model	EAN-No. 4025092*	Suitable for cylinder	Weight kg
AYP-1010	*157407	YS-10/...	9.7
AYP-1510	*157414	YS-15/... and YH-10/...	12.6
AYP-2310	*157421	YS-23/... and YH-20/...	12.1
AYP-5010	*159531	YS-50/... and YH-50/...	19.6
AYP-10010	*159548	YS-100/... and YH-100/...	46.0
AYP-20010	*159555	YH-200/...	97.0

Dimensions model AYP

Model	AYP-1010	AYP-1510	AYP-2310	AYP-5010	AYP-10010	AYP-20010
A, mm	M57 x 1.5	M67 x 1.5	M85 x 2	M125 x 2	M180 x 3	M250 x 4
B, mm	220	220	220	250	330	450
C, mm	200	200	200	250	330	450
D, mm	30	40	40	50	70	80
E, mm	120	120	120	225	300	400
F, mm	150	150	150	225	300	400
G, mm	M12	M12	M12	Ø 13.5	Ø 17.5	Ø 17.5
H, mm	M8	M8	M8	M8	M8	M8

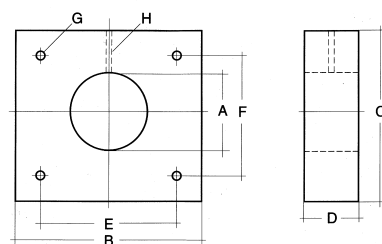

Model AYP

Clevis eye mountings model AYH

Clevis eye mountings are screwed onto the piston and bottom of the hydraulic cylinder in those cases where mounting conditions require a pivoting of the cylinder.



Technical data model AYH

Model	EAN-No. 4025092*	Suitable for cylinder	Suitable for	Weight kg
AYH-5-1	*157179	YH-5/30, YH-5/80, YH-5/150	Cylinder base	0.3
AYH-5-2	*157186	YH-5/30, YH-5/80, YH-5/150	Piston	0.3
AYH-10-1	*157193	YH-10/30, YH-10/80, YH-10/150, YH-10/250	Cylinder base	0.6
AYH-10-2	*157209	YH-10/30, YH-10/80, YH-10/150, YH-10/250	Piston	0.6
AYH-20-1	*157216	YH-20/150, YH-20/250	Cylinder base	2.1
AYH-20-2	*157223	YH-20/150, YH-20/250	Piston	2.1

Dimensions model AYH

Model	AYH-5-1	AYH-5-2	AYH-10-1	AYH-10-2	AYH-20-1	AYH-20-2
A, mm	M27 x 2	M27 x 2	M36 x 2	M27 x 2	M45 x 2	M36 x 2
B, mm	-	-	-	40	-	70
C, mm	35	35	38	38	50	50
D, mm	35	35	42	42	65	65
E, mm	15	15	25	25	35	35
F, mm	16	16	20	20	30	30
G*, mm	M35 x 1.5	M35 x 1.5	M40 x 1.5	-	M70 x 2	-
H, mm	-	-	-	21	-	24
J, mm	18	18	21	-	23	-

*G=retainer nut DIN 981

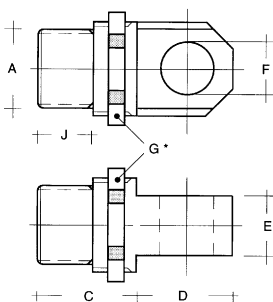

AYS-...-1 for cylinder base

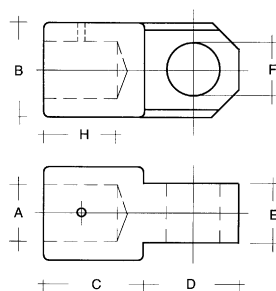

AYH-...-2 for piston

Build-up and description of the Yale hand pumps

Hand pumps are the most common power source within the area of „High Pressure Hydraulic Tools“. For this reason our hand pumps have been carefully designed and equipped with many details which make the pumps very versatile and handy in every-day applications.

Relief valve/hand wheel

The fine adjustment relief valve in connection with the large hand wheel allows by millimeter increments lifting and lowering even of the highest loads. The fact that sometimes hundreds of tons are controlled by this hand wheel, underlines the importance of this detail.

Sturdy „all-metal-design“

The robust pump head and the absence of any plastic parts result in long service life and easy maintenance over many years. Plastic reservoirs filled with oil can represent a fire danger in connection with welding or similar work.

Carrying handle

A handy carrying handle on all our hand pumps eases the transportation enormously.

Pressure relief valves

All Yale hand pumps are equipped with two pressure relief valves. They are easily adjustable from outside in those cases where pumps must be re-adjusted or a lower operating pressure should not be exceeded.

Reservoir ventilation

All hand pumps are equipped with a reservoir ventilation plug. This ensures perfect suction of hydraulic oil and allows you to use the total oil capacity of the reservoir.

Two-stage output

All Yale hand pumps have two-stage design (except HPS-1/0.7). This allows an increased speed and efficient working during unloaded conditions of the hydraulic cylinder. The switch-over from the low pressure to the high pressure stage is done automatically.

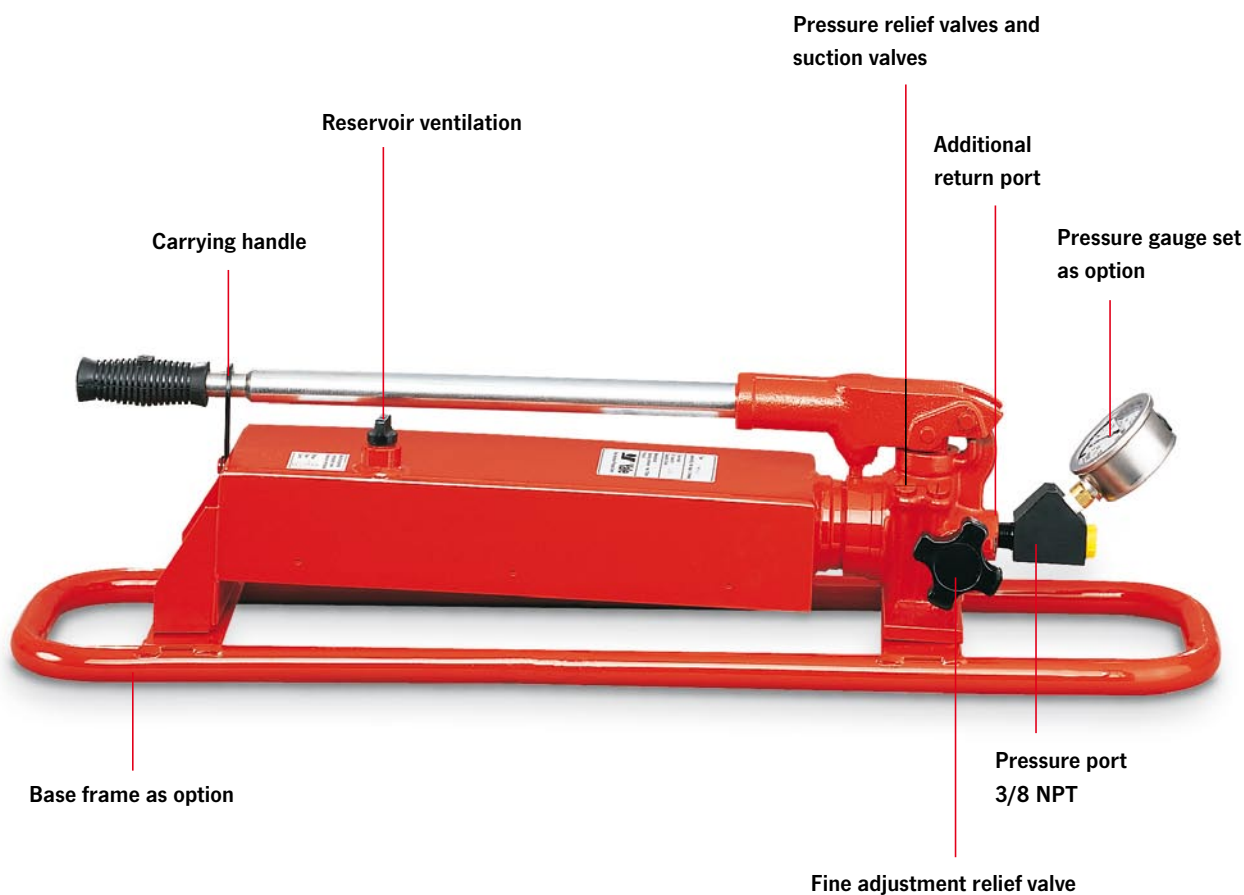

Delivered ready to use

All Yale hand pumps are supplied ready to use incl. hydraulic oil.

Easy-maintenance-design

There is no need to disassemble the Yale hand pumps in case of service work. All parts like suction and pressure valves, seals, packings etc. are accessible from the outside.

All hand pumps have the same design

The same design (build-up) for all Yale hand pumps with the exception of the reservoirs allows the interchangeability of all components. Therefore spare part stocks can be kept to an absolute minimum. Only one spare part kit is necessary to service all hand pumps.

Excellent suction properties

Yale hand pumps suck and displace 100 % of their volume per stroke. This results both in a high efficiency as well as a rapid cylinder movement.

Interchangeability

All Yale hydraulic cylinders, hand pumps and other components are fully interchangeable and can be combined with all other 700 bar hydraulic lines. All components have the standard oil port and same coupler parts.

Additional return oil port

All Yale hand pumps are equipped with a return port to the reservoir. This detail is very advantageous as many hand pumps are integrated in more complex hydraulic circuits.

Base frame

On request you can get base frames for the most common hand pumps. These base frames add to the stability and protection of the hand pumps, in particular when used in the field or on a construction site.

Pressure gauge

Appropriate pressure gauges with the corresponding adaptors are shown.



Hand pump type: HPH...
With integrated pressure gauge GGY-631 and gauge adaptor set GA-704.

Hand pumps for double-acting cylinders with relief valve and 4/2-way directional valve

Unlike conventional pumps, all Yale hand pumps of the type HPH (with 4/2-way directional valve for double-acting cylinders) include a precision relief valve in addition to the directional control valve.

Manual directional control valves switch over abruptly, thus causing undesired pressure surges in the system under load.

The additional relief valve in all HPH-hand pumps allows a precise lowering of the load without any pressure shocks. All components have the standard oil port and same coupler parts.

Further advantage of this design:

The pressure gauge shows the pressure as pushing and as pulling force. The combination of a 4-way directional valve with a sensitive relief valve allows a controlled pressure relief without pressure shocks.

! A selection chart "cylinder/hand pumps" can be found on pages 261 to 263.



Hand pumps for single-acting cylinders model HPS

Yale hand pumps are easy to use and operate independently of any external energy source. They are designed for maximum 700 bar system pressure and will allow each Yale hydraulic cylinder to utilize its maximum capacity.

The two stage system reduces pumping time. Stage 1 allows rapid piston travel under no load or light load conditions. The pump automatically switches to stage 2 when the piston is loaded and a higher force is required from top.

The Yale hand pump is an all-steel construction designed for rough use and has a high-efficiency pumping action.

The handle can be locked for easy carrying.

The large and easy to control return valve allows the operator to precisely control the return stroke. Other standard features include a large and easy to control hand wheel, air bleeding and oil filling plug, large support feet for stability, tilted tank to increase usable oil volume and ergonomic handle grip.

Features

- Operating pressure max. 700 bar.
- Two stage operation with automatic switch-over (except HPS-1/0.7 A).
- Large reservoir volumes.
- With pressure relief valves, adjustable from the outside.
- Fine adjustable relief valve (handwheel).
- Robust all-steel construction.
- HPH pumps are equipped with a 4-way control valve plus a precision-adjustable relief valve.
- Oil port thread: 3/8 NPT.
- Incl. oil filling.
- Pressure gauges with corresponding adaptors are also available as accessories.

The hydraulic hoses are the connection between the hand pump and the hydraulic cylinders and are consequently to be selected separately.

See page 237.

Technical data model HPS

Model	EAN-No. 4025092*	Displacement	Reservoir volume cm ³	Displacement 1 st stage cm ³	Displacement 2 nd stage cm ³	Weight kg
HPS-1/0.7 A	*159081	single-stage	700	–	2	7.0
HPS-2/0.3 A	*152969	two-stage	300	5	1	3.5
HPS-2/0.7 A	*159098	two-stage	700	11	2	7.0
HPS-2/2 A	*159104	two-stage	2000	11	2	10.0
HPS-2/4 A	*159111	two-stage	4000	11	2	13.0
HPS-2/6.5 A	*159128	two-stage	6500	11	2	21.0
HPS-2/10 A	*159135	two-stage	10000	11	2	27.0

Dimensions model HPS

Model	HPS-1/0.7 A	HPS-2/0.3 A	HPS-2/0.7 A	HPS-2/2 A	HPS-2/4 A	HPS-2/6.5 A	HPS-2/10 A
A, mm	590	500	590	595	715	715	880
B, mm	95	100	95	65	65	65	65
C, mm	160	100	160	160	160	200	160
D, mm	165	110	165	165	180	180	190
E, mm	55	35	55	55	55	55	55
F, mm	80	35	80	80	80	80	80

Dimensions approx.

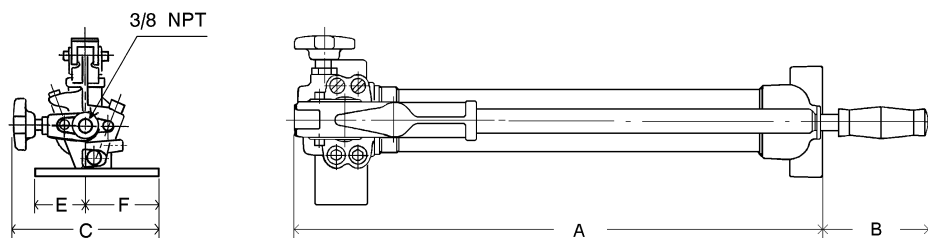

Model HPS



Hand pumps for double-acting hydraulic cylinders model HPH

With 4-way valve and relief valve (hand wheel)

All Yale hand pumps of the type HPH are designed as double-acting cylinders. Basically they do not differentiate from the series HPS, but are equipped with a 4/3-way directional valve.

The fine adjustable relief valve remains unaffected and permits a sensitive pressure relief. Pressure gauge and adaptor can be delivered as accessories.

Technical data model HPH

Model	EAN-No. 4025092*	Displacement	Reservoir volume cm ³	Displacement 1 st stage cm ³	Displacement 2 nd stage cm ³	Weight kg
HPH-2/0.7 A	*159159	two-stage	700	11	2	8
HPH-2/2 A	*159166	two-stage	2000	11	2	11
HPH-2/4 A	*159173	two-stage	4000	11	2	14
HPH-2/6.5 A	*159180	two-stage	6500	11	2	22
HPH-2/10 A	*159197	two-stage	10000	11	2	28

Dimensions model HPH

Model	HPH-2/0.7 A	HPH-2/2 A	HPH-2/4 A	HPH-2/6.5 A	HPH-2/10 A
A, mm	590	595	715	715	880
B, mm	95	65	65	65	65
C, mm	160	160	160	200	160
D, mm	165	165	180	180	190
E, mm	55	55	55	55	55
F, mm	80	80	80	80	80
G, mm	85	85	85	85	85

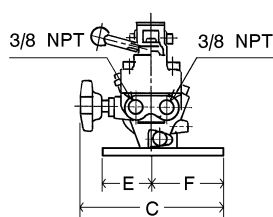

Model HPH

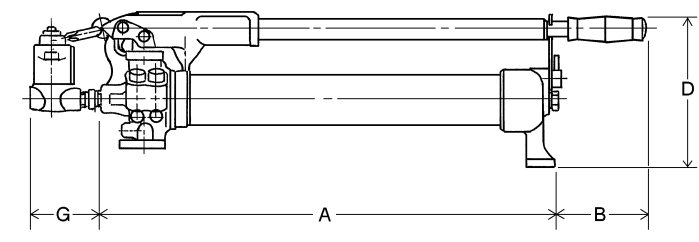

Base frames for hand pumps model HPB

These base frames add to the stability of your hand pump, in particular when used in the field or on a construction site where hand pumps are frequently operated on uneven and soft ground.

At the same time the hand pumps are protected from sand, humidity and possible damage.

The assembly of the base frames is very easy; just three holes have to be bored to mount the frame to the hand pump.



Technical data model HPB

Model	EAN-No. 4025092*	Suitable for hand pumps	Weight kg
HPB-2	*156684	HPS-1/0.7 A + HPS-2/0.7 A + HPS-2/2 A + HPH-2/0.7 A + HPH-2/2 A	1.3
HPB-4	*156691	HPS-2/4 A + HPH-2/4 A	1.8
HPB-6	*156707	HPS-2/6.5 A + HPH-2/6.5 A	1.9

Dimensions model HPB

Model	HPB-2	HPB-4	HPB-6
Dimensions A, mm	765	885	910
Dimensions B, mm	190	190	190

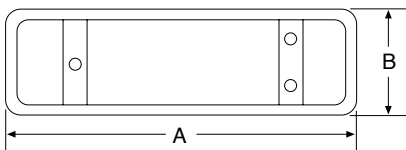

HPB Base frame

Hand pump model HPS-1/1500 A

This high pressure pump is particularly designed to pressurize special components like hydraulic nuts, bolt tensioning cylinders, hydraulic safety couplers or similar systems.

The pump is equipped with a pressure limiting valve which discharges to the atmosphere. The pump can be set to any pressure between zero and 1500 bar. The pressure gauge is standard and allows permanent pressure control.

Due to a reservoir below the pump can be operated in any position (hand held design). When operating with this pump, it must be held with two hands. The depicted hydraulic hose is not part of the delivery package.



Hand pumps model TWAZ

Max. operating pressure 2000 bar

These high-performance hand pumps allow a very rapid pressure build-up due to their two-stage design. Both pressure stages are equipped with a limiting valve which can easily be adjusted from outside.

High pressure hand pumps are used for special applications like pressurizing hydraulic nuts and safety couplings, hydrostatic testing, bolt tensioners, high pressure oil injection for bushing removal, pretensioning of anchors, for test applications in laboratories and as a power source within test stands and propeller press systems.



Accessories for hand pumps model TWAZ



Optional: pressure gauge, model: GGY-2500.



Optional: pressure gauge-adaptor, model GA-2000.



Optional: adaptor, model: FY-201 (M22 x 1.5 on G 1/4).



Optional: hydraulic hoses, model: HH-2001-20, max. pressure: 2000 bar.

Technical data model HPS-1 and model TWAZ

Model	EAN-No. 4025092*	Max. pressure bar	Reservoir volume cm ³	Displacement 1 st stage cm ³	Displacement 2 nd stage cm ³	Oil port	Pressure gauge	Pressure gauge model	Gauge adaptor	Pressure relief valve	Weight kg
HPS-1/1500 A	*162876	1500	160	–	0.3	G 1/4	standard	GGY-639	–	yes	2.6
TWAZ-0.7	*159920	2000	700	8	0.6	M22 x 1.5	optional	GGY-2500	GA-2000	yes	7.0
TWAZ-1.3	*159937	2000	1300	13	1.0	M22 x 1.5	optional	GGY-2500	GA-2000	yes	9.0
TWAZ-2.3	*159951	2000	2300	31	1.6	M22 x 1.5	optional	GGY-2500	GA-2000	yes	16.0

Foot pump model FPS

Operating pressure 700 bar

Used to operate single-acting hydraulic cylinders, especially for repeated applications, such as checking of welding samples, pressing of connection components (crimping), actuating of clamping devices, as well as for all applications, where it is necessary to keep hands free.

The pump can be used everywhere, as it is independent of an external energy source and is easily portable. An extremely good stability guarantees a comfortable and safe operation up to the highest pressure. It is a „real“ foot operated pump, as the return stroke of the connected hydraulic cylinder is released by foot control.

Features

- Operating pressure max. 700 bar.
- Absolute stability due to large base plate.
- Minimized labour fatigue.
- Operating pressure adjustable. Valves accessible from the outside.
- Return stroke of cylinder also controlled by foot operation.
- Oil port 3/8 NPT.

Option

- Pressure gauges and suitable adaptors.
- Hydraulic hoses.



Technical data model FPS

Model	EAN-No. 4025092*	Operating pressure bar	Displacement 1 st stage cm ³	Displacement 2 nd stage cm ³	Reservoir volume useable cm ³	Weight kg
FPS-2/0.5 A	*160155	700	11	2	500	7



PY-04/2/5/2M

PY-04/2/5/4M

Operation of the power pump model PY-04/2/5/2E:

By activating the push button number 1, the motor starts and the cylinder advances. In the neutral position the pressure is held. By activating the push button number 2, the solenoid valve is activated, the pressure decreases and the hydraulic cylinder retracts.

Compact electric motor pumps model PY-04

Portable, max. operating pressure 700 bar

These light-weight but powerful two-stage pumps are particularly designed for maintenance and repair jobs. Depending on their type, they can either operate single-acting or double-acting hydraulic cylinders.

The ideal combination of manual operated valve and remote pendant control provides the operator with ample freedom of motion and ensures a safe „holding of the load“.

The remote pendant control (1.5 m) is used to start the motor even under full load. The function for both manual valves is as follows: - advance - stop - return - With their light weight and convenient carrying handle, these pumps can be easily transported. Pumps are equipped with thermal overload protection and are supplied with hydraulic oil.

Operation of the power pump model PY-04/2/5/2 M:

The 2/2-way manual valve operates together with a pilot operated unloading valve, so that the two valve positions result in the following two control possibilities:

1. Cylinder holds pressure after motor stop.
2. Cylinder automatically retracts after motor stop.

Technical data model PY

Model	EAN-No. 4025092*	Control valve	Max. operating pressure	No load stroke l/min up to 30 bar	Under load stroke l/min up to 700 bar	Useable reservoir volume l	Connecting value	Cable remote control m	Speed rpm	Protection standard	Weight, without oil, approx. kg
PY-04/2/5/2 M	*153263	2/2-way manual valve	700	4.0	0.23	5.0	0.37 kW - 230 V-1Ph	1.5	2800	IP 50	24
PY-04/2/5/4 M	*153294	4/3-way manual valve	700	4.0	0.23	5.0	0.37 kW - 230 V-1Ph	1.5	2800	IP 50	26
PY-04/2/5/2 E	*163392	2/2-way solenoid	700	4.0	0.23	5.0	0.37 kW - 230 V-1Ph	1.5	2800	IP 50	28

Mini hydraulic pumps model PAY

With compressed air driven motor 700 bar

These mini-pumps are driven by an air-powered motor and can be connected to any supply source of compressed air. These compact low-cost pumps can operate all single-acting or double-acting hydraulic cylinders up to a max. operating pressure of 700 bar.

Due to large reservoirs, large cylinders or multiple cylinders can be operated. The use of an inline air filter-lubricator is recommended.

The hydraulic pressure can be infinitely adjusted on the regulator of the air-lubricator unit. The air-driven motor guarantees 100 % explosion protection.

Pumps for double-acting hydraulic cylinders are equipped with an additional 4-way control valve type VHH-4/3. The connected hydraulic cylinder is controlled - advance - stop - return - by the universal pedal, which can be either hand or foot-operated.



Control of cylinder motion

- Pedal in neutral position - motor stands still, cylinder stands, pressure is held.
- Pedal depressed - motor starts, cylinder advances, pressure is built-up.
- Pedal pushed forward - motor stands still, pressure is released, cylinder retracts.

Technical data model PAY

Model	EAN-No. 4025092*	For cylinders	Reservoir volume l	Max. oil pressure bar	Oil-displacement l/min	Requested air pressure bar	Air con- sumption l/min	Oil port	Air port	Weight kg
PAY-6	*153270	single-acting	1.5	700	0.85 up to 0.08	7	560	3/8 NPT	1/4 NPT	6.3
PAY-6-5	*160735	single-acting	5.0	700	0.85 up to 0.08	7	560	3/8 NPT	1/4 NPT	12.0
PAY-64	*153614	double-acting	1.5	700	0.85 up to 0.08	7	560	3/8 NPT	1/4 NPT	7.5
PAY-64-5	*160940	double-acting	5.0	700	0.85 up to 0.08	7	560	3/8 NPT	1/4 NPT	13.0

**For information on training
please see pages 4-5.**



PY-07/3/20/4M



PY-07/3/10/4E

Electric hydraulic power packs model PYE and model PY

Single-stage and two-stage

Power packs are easy to operate as they are ready assembled and easy to control.

The use of power packs is always recommended when jobs have to be done in a time-saving and efficient way, when repeating jobs have to be finished off, quick cylinder cycles have to be achieved or if large oil volumes in connection with high tonnage cylinders have to be transmitted.

Two-stage output

The standard Yale power packs are equipped with two-stage pumps, which means that a low pressure stage fills the connected hydraulic cylinder quickly up to a pressure of 80 bar. The high pressure stage is activated automatically from 80 bar up to 700 bar, while the low pressure stage is discharged back to the reservoir. This economic solution avoids heating-up, saves energy and keeps the power packs compact.

Single-stage output model PYE

The hydraulic packs have single-stage pumps. These packs deliver between 0 and 700 bar with the same volume (high-pressure stage).

Control/Operation

The motion control of the connected hydraulic cylinder is done by operating the directional valve.

Do you have a single-acting or a double-acting hydraulic cylinder?

The directional control valve has to correspond to the a.m. functional principle of the hydraulic cylinder to be operated. Depending on these principles the power packs are equipped with a:

- 3/3-way valve to operate single-acting hydraulic cylinders (connection with one hydraulic hose)
- 4/3-way valve to operate double-acting hydraulic cylinders (connection with two hydraulic hoses)

The directional control valves are available either as manual or solenoid operated valves.

Operation of the directional valves

Depending on the way of operation, there are manual or solenoid operated valves. Manual valves are controlled by shifting the operating lever and represent the economic way of control.

These valves have 3 lever positions:

- advance - hold - retract -

Solenoid valves

Solenoid valves have the advantage that they are controlled by a pendant remote control box which makes the operator independent from the power pack, making it easier for him to monitor the job.

The solenoid valves are controlled by two push buttons - **advance** - **hold** - **retract** -

In neutral position - **hold** - the valves rest in pressureless circuit. Pressure and force of the connected cylinder are held without pressure drop. The complete electrical set-up (with 24V control) belongs to the scope of delivery. Solenoid valves allow a very ergonomic operation and offer a quick and precise switching (millimeterwise) of the connected hydraulic cylinder.

Pressure-less circuit

In neutral position all directional valves rest in pressureless circuit which means that the oil flow coming from the rotating pump is guided back to the reservoir without creating any pressure build-up.

Special solenoid valve configurations

Some applications require a special valve configuration, e.g. the independent control of several hydraulic cylinders from a single power pack. In such cases the complete valve build-up and electrical control is made to the customer's requirements.

Pressure-Guard power packs

By using an electro-hydraulic pressure switch and a special electric control, power packs can selfcontrol their pre-adjusted pressure. In applications where the pressure (load) should be applied over a very long period, the connected power pack is switched on and off automatically and replaces the pre-set pressure in case a pressure drop has occurred.

Trolleys

For all power packs we offer a cart-frame for flexible movement from job to job. Cart-frames are equipped with 2 fixed and 2 swivel castors.

Oil cooler

For certain applications, especially when power packs are continuously operated and the oil temperature could exceed 60° C, the use of an oil cooler is recommended.

Hydraulic oil

All power packs are designed to be operated with standard hydraulic oil (specification ISO VG 32). For certain operating conditions the viscosity class of the hydraulic fluid can be varied. All power packs are supplied including oil.

Features

- Robust packs, also capable for continuous applications.
- Suitable for all jobs in workshops and on construction sites where hydraulic force is required; supplied ready to use.
- On-off motor switch and 3 m motor connecting cable.
- With carrying handles, oil level gauge, oil filler/reservoir ventilation plug.
- Incl. pressure gauge GGY-631.
- Two-stage displacement, which means a rapid advance without load, as well as an automatic switch into the 2. phase by a congruous load.
- Low noise level due to standard motors with 1450 rpm.
- Further motor voltage and oil reservoirs on request.
- With manual or solenoid operated directional valves.
- Solenoid valves with 3 m remote control box (with 2 push-buttons) and pressure set valve as standard. Adjustable from 0-700 bar.
- 24 V - low voltage control includes a sturdy metal electric control box and ready to use set up.

Hydraulic Jacks & Tools Electric hydraulic power packs

Two-stage electric hydraulic power packs, 700 bar

Model	Reservoir size				Control valve (directional valve)				Motor power kw	Displacement, two-stage	
	10 l	20 l	30 l	50 l	manual valve		solenoid valve			approx. l/min 0 - 80 bar	approx. l/min 80 - 700 bar
					3/3-way	4/3-way	3/3-way	4/3-way			
PY - 07/3/10/3 M	•	-	-	-	•	-	-	-	0.75	6.0	0.6
PY - 07/3/10/4 M	•	-	-	-	-	•	-	-			
PY - 07/3/20/3 M	-	•	-	-	•	-	-	-			
PY - 07/3/20/4 M	-	•	-	-	-	•	-	-			
PY - 07/3/20/3 E	-	•	-	-	-	-	•	-			
PY - 07/3/20/4 E	-	•	-	-	-	-	-	•			
PY - 11/3/20/3 M	-	•	-	-	•	-	-	-	1.1	8.5	1.0
PY - 11/3/20/4 M	-	•	-	-	-	•	-	-			
PY - 11/3/30/3 M	-	-	•	-	•	-	-	-			
PY - 11/3/30/4 M	-	-	•	-	-	•	-	-			
PY - 11/3/20/3 E	-	•	-	-	-	-	•	-			
PY - 11/3/20/4 E	-	•	-	-	-	-	-	•			
PY - 11/3/30/3 E	-	-	•	-	-	-	•	-			
PY - 11/3/30/4 E	-	-	•	-	-	-	-	•			
PY - 22/3/30/3 M	-	-	•	-	•	-	-	-	2.2	18.0	2.1
PY - 22/3/30/4 M	-	-	•	-	-	•	-	-			
PY - 22/3/50/3 M	-	-	-	•	•	-	-	-			
PY - 22/3/50/4 M	-	-	-	•	-	•	-	-			
PY - 22/3/30/3 E	-	-	•	-	-	-	•	-			
PY - 22/3/30/4 E	-	-	•	-	-	-	-	•			
PY - 22/3/50/3 E	-	-	-	•	-	-	•	-			
PY - 22/3/50/4 E	-	-	-	•	-	-	-	•			

Code explanation

- Directional valve : 3 = for single-acting, 4 = for double-acting cylinder, M = manual valve, E = solenoid valve
- Reservoir size : in liters (other reservoir sizes on request)
- Motor voltage : 3 = 380-420 V-3 Ph (Euro-voltage), 2 = 230 V-1 Ph, (other voltages on request)
- Hoist motor : 07 = 0.75 kW, 11 = 1.1 kW, 22 = 2.2 kW, 30 = 3 kW, 55 = 5.5 kW, 75 = 7.5 kW, 110 = 11 kW
- Type of motor : PY = electric motor, PAY = air motor, PGY = petrol driven motor (4 cycle)

Single-stage electric hydraulic power packs, 700 bar

Model	Reservoir size				Control valve (directional valve)				Motor power kw	Displacement l / min 0 - 700 bar
	10 l	20 l	30 l	50 l	manual valve		solenoid valve			
					3/3-way	4/3-way	3/3-way	4/3-way		
PYE - 03/3/10/3 M	•	-	-	-	All valve and reservoir combinations available.				0.35	0.3
PYE - 03/3/10/4 M	•	-	-	-						
PYE - 07/3/10/3 M	•	•	•	•						
PYE - 07/3/10/4 M	•	•	•	•						
PYE - 11/3/20/3 M	-	•	•	•						
PYE - 11/3/20/4 M	-	•	•	•						
PYE - 22/3/20/3 M	-	•	•	•						
PYE - 22/3/20/4 M	-	•	•	•						

High performance electric hydraulic power packs, 700 bar, single-stage

Model	Reservoir size			Control valve (directional valve)				Motor power kw	Displacement l / min 0 - 700 bar
	50 l	100 l	150 l	manual valve		solenoid valve			
				3/3-way	4/3-way	3/3-way	4/3-way		
PYE - 40/3/50/4 M	•	-	-	All valve and reservoir combinations available.				4.0	2.7
PYE - 55/3/70/4 M	•	-	-						
PYE - 75/3/100/4 M	-	•	-						
PYE - 110/3/150/4 M	-	-	•						
PYE - 180/3/150/4 M	-	-	•						



Hydraulic power pack with protection cage

This power pack is specially designed for general lifting applications in construction areas. Equipped with an optimized valve configuration, including 4-way manual directional valve VHP-4/3-1, safety-check valve VSM-21, pressure relief valve VPR-3 and 2 pressure gauges for permanent load control.



Hydraulic power pack with 4-way manifold MY-44-GYA

The most economic way for a pressure-independent and individual control of 4 single-acting hydraulic cylinders. The additionally mounted safety-check valve VSM-21 avoids uncontrolled pressure drops and the built-in throttle valve allows a precise (millimeterwise) lowering even of the highest loads. Four pressure gauges allow a permanent reading of the individual loads. On request, the power packs can be equipped with a handy cart-frame to make the operation flexible. This type of power pack can be supplied in all sizes of the PY and PYE series.



Hydraulic power pack with 4-times solenoid valve

The quadruple solenoid valve block ensures a pressure-independent and individual control of 4 double-acting hydraulic cylinders. Solenoid valves offer several well known advantages such as: ergonomic and safe control by pendant remote control, exact load hold, precise and quick switch characteristics and many more.



Double-hydraulic power pack

In order to realise very high oil flows, two independent pump systems can be combined in one large reservoir. A gear pump ensures an extremely high oil flow up to 250 bar while the high-pressure stage is generated by a high performance radial piston pump. Each pump is equipped with its own solenoid control valve so that the individual oil flows can be generated or discharged on request.



PMF-15/3/40/4 x 3 M

All extra loads can be meter read permanently.

Multiple-flow hydraulic power packs model PMF

Multiple-flow hydraulic pumps can advance 4 cylinders with the same speed in the same time by injecting equal amounts of hydraulic oil into each individual cylinder. This principle allows a synchronized lifting of machines or similar loads from a central point. Even under different loading conditions the cylinders advance in synchronisation.

A levelling of a lopsided load is easily possible by an individual control of each single cylinder. The lifting phase is initiated by a push-button remote control box and can be interrupted and continued at any time.

Lowering of the load is done by operating the directional valve in connection with the throttle valve individually for each circuit. The multiple-flow pumps can drive all kinds of hydraulic cylinders, machine jacks or stage lifts.

Features

- 4-point synchronized lift due to 4 equal, independent and individual oil flows.
- 4 manually operated directional valves, or 4 solenoid directional valves allow an individual or joint control of all 4 connected cylinders (easy levelling of a load possible).
- Safe load hold due to check valve in each circuit.
- One-man central operation.
- Motor on-off switch by means of a pendant remote control box in connection with manual valves.
- A complete remote control box to operate the solenoid valves.

Option

- All pump packs are also available with 4/3 direction-valves (for controlling the double-acting hydraulic cylinders).
- All power packs can be supplied with a protection frame suitable for on-site operation. Also cart-frames with 2 fixed and 2 swivel castors are available on request.

Scope of delivery

For each of the four circuits the ready to use supply includes: glycerine-damped pressure gauge, 3-way control valve, safety-check valve, a female coupler-half as connecting port. Furthermore: hydraulic oil, carrying handles, motor on-off switch, motor connecting cable, pendant remote control, electro-box with transformer and motor relays, oil level gauge and oil-filler/ventilation plug. All multiple-flow power packs are also available with 4-way directional valves in order to operate double-acting hydraulic cylinders.

4-multiple-flow power packs with solenoid directional valves model PMF

4-multiple-flow power packs with solenoid directional valves to advance 4 hydraulic cylinders independently and in a synchronized way by means of solenoid valves with a pendant remote control box.

The solenoid valves in connection with safety-throttle valves allow a precise control of all connected hydraulic cylinders.

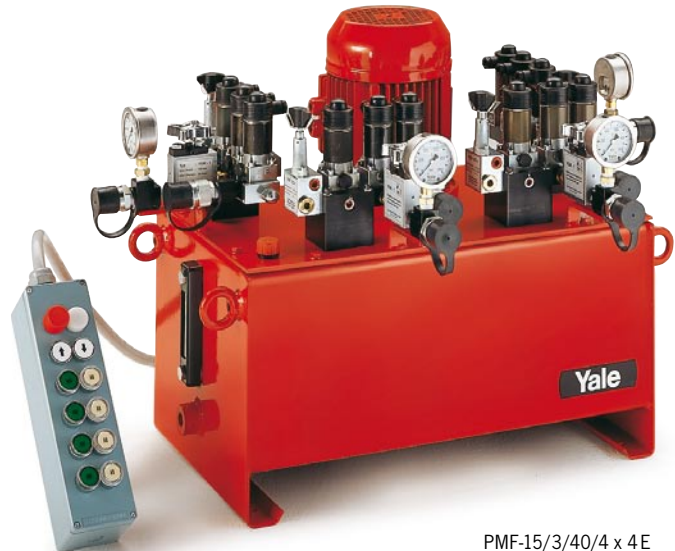

PMF-15/3/40/4 x 4 E

Technical data model PMF

Model	EAN-No. 4025092*	Operating pressure bar	Displacement l/min	Manual valve	Solenoid valve	Motor remote control	Reservoir size l	E-motor
PMF-07/3/20/2 x 3 M	*163521	2 x 700	2 x 0.3	•	–	•	20	0.75 kW-400 V-3 Ph
PMF-07/3/20/2 x 3 E	–	2 x 700	2 x 0.3	–	•	–	20	0.75 kW-400 V-3 Ph
PMF-15/3/20/2 x 3 M	–	2 x 700	2 x 0.6	•	–	•	20	1.5 kW-400 V-3 Ph
PMF-15/3/20/2 x 3 E	–	2 x 700	2 x 0.6	–	•	–	20	1.5 kW-400 V-3 Ph
PMF-15/3/40/4 x 3 M	*157827	4 x 700	4 x 0.3	•	–	•	40	1.5 kW-400 V-3 Ph
PMF-15/3/40/4 x 3 E	*160681	4 x 700	4 x 0.3	–	•	–	40	1.5 kW-400 V-3 Ph
PMF-30/3/40/4 x 3 M	*160957	4 x 700	4 x 0.6	•	–	•	40	3.0 kW-400 V-3 Ph
PMF-30/3/40/4 x 3 E	*160902	4 x 700	4 x 0.6	–	•	–	40	3.0 kW-400 V-3 Ph
PMF-55/3/100/4 x 3 M	–	4 x 700	4 x 1.0	•	–	•	100	5.5 kW-400 V-3 Ph
PMF-55/3/100/4 x 3 E	–	4 x 700	4 x 1.0	–	•	–	100	5.5 kW-400 V-3 Ph
PMF-110/3/100/4 x 3 M	*163972	4 x 700	4 x 2.1	•	–	•	100	11.0 kW-400 V-3 Ph
PMF-110/3/100/4 x 3 E	*162128	4 x 700	4 x 2.1	–	•	–	100	11.0 kW-400 V-3 Ph

All multiple-flow power packs are also available with 4-way directional valves in order to operate double-acting hydraulic cylinders model PMF.



In addition all valves are equipped with a second pressure oil port P at the back of the valve base. This port can easily be used to connect a pressure gauge and a pressure relief valve (e.g. VPR-1). The oil port T shall always be connected to the reservoir without any back pressure.

Directional valves model VHP and model VHH

Manually operated

These directional valves control the oil flow in combination with hydraulic power packs (YHH-4/3 with hand pumps).

All valves have 3 lever positions to control movement of the connected hydraulic cylinder:

1. left: cylinder advance.
2. middle: cylinder neutral (pressureless circuit).
3. right: cylinder retracts.

In the middle position (hold) the piston of the cylinder stops and the oil flow is guided in a circuit back to the reservoir (P to T). The valves can be flanged directly onto power packs or remote connected by using hydraulic piping.

Technical data model VHP and model VHH

Model	EAN-No. 4025092*	Max. pressure l/min	Size	Oil ports	Hydraulic symbol	Applications
VHP-3/3-1	*155175	8 - 16	1	3/8 NPT		3/3-way valve with "open centre" in middle position (pressureless circuit) to control single-acting hydraulic cylinders, standard valve for smaller power packs, size 1
VHP-3/3-2	*154857	20 - 40	2	3/8 NPT		3/3-way valve with "open centre" in middle position (pressureless circuit) to control single-acting hydraulic cylinders, standard valve for larger power packs, size 2
VHP-3/3-1 CC	*155182	8 - 16	1	3/8 NPT		3/3-way valve with "closed centre" in middle position to control single-acting hydraulic cylinders, only for specific multiple valve configuration, size 1
VHP-3/3-2 CC	*154932	20 - 40	2	3/8 NPT		3/3-way valve with "closed centre" in middle position to control single-acting hydraulic cylinders, only for a multitude of valve operations, size 2
VHP-4/3-1	*155199	8 - 16	1	3/8 NPT		4/3-way valve with "open centre" in middle position (pressureless circuit) to control double-acting hydraulic cylinders, standard valve for smaller power packs, size 1
VHP-4/3-2	*154864	20 - 40	2	3/8 NPT		4/3-way valve with "open centre" in middle position (pressureless circuit) to control double-acting hydraulic cylinders, standard valve for larger power packs, size 2
VHP-4/3-1 CC	*154932	8 - 16	1	3/8 NPT		4/3-way valve with "closed centre" in middle position to control double-acting hydraulic cylinders, only for specific multiple valve configuration, size 1
VHP-4/3-2 CC	*154956	20 - 40	2	3/8 NPT		4/3-way valve with "closed centre" in middle position to control double-acting hydraulic cylinders, only for specific multiple valve configuration, size 2
VHH-4/3	*154840	2 - 3	small special design	1/4 NPT		4/3-way valve with "open centre" in middle position (pressureless circuit) to control double-acting hydraulic cylinders. Special design to be mounted directly to all HPS hand pumps (with connecting set FY-703). Also suitable for small hydraulic power packs.

Solenoid directional valves model VEP

700 bar, incl. pressure set valve

Solenoid operated valves are used to control the connected hydraulic cylinder by means of a pendant remote control or further electrical controls like pressure switches or limit switches.

Control principle

All solenoid valves have 3 positions:

- advance - stop - retract -

In neutral position (stop) the valves switch to „pressureless circuit“ so that the oil flow is guided back to the reservoir while the connected cylinder is safely held under pressure.

Normally solenoid valves are mounted directly onto power packs but can also be remote mounted by using hydraulic piping.

Design

Long life direct controlled ball seal valves with leak-free “load hold function“ in neutral position.

The solenoids guarantee a very quick reaction of the valves so that cylinders can be controlled millimeter-wise. The valves are suitable for continuous operation (100 % on/off duration).

Modular design

The modular principle allows special valve configurations e.g. control of multiple cylinder systems or specific control sequences.

Pressure adjustment

All solenoid valves are equipped with a precision-adjustable pressure set valve which allows the system pressure (force of cylinder) to be limited to any value from 0 to 700 bar.

Pressure gauge

A glycerine-damped pressure gauge GGY-631 is standard with solenoid valves, 0-1000 bar, Ø 63 mm.



VEP-3/3-1

VEP-4/3-1

Mounting flange

The valve flanges are designed in a way that valves (with pressure connector) can easily be mounted onto Yale power packs.

Option

The connector model FY-905 is to be ordered separately.

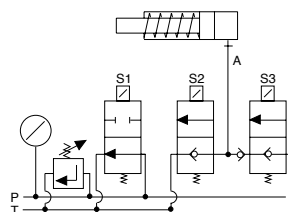

VEP-3/3-1 and VEP-3/3-2 for single-acting cylinders

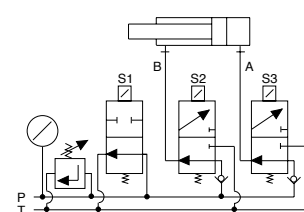

VEP-4/3-1 and VEP-4/3-2 for double-acting cylinders

! If oil ports A and B should have 3/8 NPT the adaptor model FY-30 is to be ordered separately.

Technical data model VEP

Model	EAN-No. 4025092*	Control	For cylinders	Max. operating pressure	Size	Max. oil flow l/min	Control voltage	Oil ports P T	Pressure relief valve	Weight kg
VEP-3/3-1	*154994	3/3-way	single-acting	700	1	12	24 V =	3/8 NPT	yes	4.1
VEP-3/3-2	*154987	3/3-way	single-acting	700	2	25	24 V =	3/8 NPT	yes	7.9
VEP-4/3-1	*155007	4/3-way	double-acting	700	1	12	24 V =	3/8 NPT	yes	4.1
VEP-4/3-2	*155014	4/3-way	double-acting	700	2	25	24 V =	3/8 NPT	yes	7.9



Safety-check valves model VSM

700 bar

These safety-check valves are used for those applications where pressure drops (e.g. holding of a lifted load) must be avoided. Depending on the location in a hydraulic circuit these valves can have different functions. The model VSM-11 can be directly screwed into the oil port of a hydraulic cylinder and works at this location as a "hose break fuse". The design of the VSM-21 is suitable for a combination with VHP directional valves.

At this location the VSM-21 ensures that the pressure is held precisely and that pressure drops caused by operating the directional valve are avoided.

Operation

After closing the relief valve (hand wheel) the cylinder can be advanced via the by-pass. In direction to the cylinder the valves always have free flow. The built-in check valve ensures that a pressurized cylinder (e.g. a lifted load) is held precisely in stop position. A smooth lowering speed can be adjusted by opening the throttle valve (hand wheel) in order to relieve the pressure. A safety pressure valve protects the cylinder from being overloaded by external loading.

Selection advice

If the valve is to be screwed directly into a hydraulic cylinder, please order model VSM-11.

If the valve is to be combined with the directional valve of a power pack please order model VSM-21.

Technical data model VSM

Model	EAN-No. 4025092*	Max. operating pressure bar	Control	Oil-port cylinder side A	Oil-port pump side B	Width mm	Weight kg
VSM-11	*157797	700	Check valve	3/8-18 NPT outer	3/8-18 NPT inner	6	0.9
VSM-21	*158442	700	Check valve	3/8-18 NPT inner	3/8-18 NPT outer	6	1.0

Dimensions model VSM

Model	VSM-11	VSM-21
Length, mm	75	75
Width, mm	25	25
Height, mm	100	100

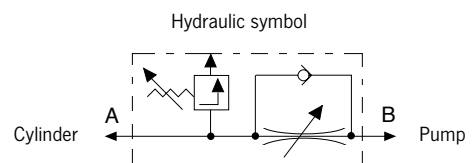

Throttle-/Shut-off valves model VHM

700 bar

These valves are used to shut-off hydraulic lines especially in multiple cylinder systems. The needle valve VHM-1 also allows you to throttle an oil flow especially within lifting applications.



Technical data model VHM

Model	EAN-No. 4025092*	Max. operating pressure bar	Control	Oil ports both ends	Width mm	Weight kg
VHM-1	*154819	700	Needle	3/8-NPT inner	6	0.4
VHM-2	*154963	700	Ball	3/8-NPT inner	6	0.9

Dimensions model VHM

Model	VHM-1	VHM-2
Length, mm	75	75
Width, mm	28	45
Height, mm	100	75

Hydraulic symbol

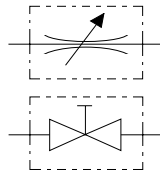



Pressure relief valves model VPR

0 - 700 bar

Pressure relief valves are used when the system pressure (force of the connected hydraulic cylinder) should not exceed a certain value. These precision valves can be easily adjusted and feature themselves through a high and precised repetition. For the decision of a pressure relief valve only the displacement of the high pressure stage is off value.

After achieving the set pressure value, the excessive oil is guided back to the reservoir (pressureless).

Technical data model VPR

Model	EAN-No. 4025092*	Control range bar	Oil ports P	Oil ports T	Max. oil flow l/min	Weight kg
VPR-1	*155212	0-700	G3/8	G 1/4	10	0.8
VPR-3	*154888	0-700	3/8-NPT	1/4-NPT	5	1.2
VPR-6	*154871	0-700	3/8-NPT	1/4-NPT	16	2.2

Dimensions model VPR

Model	VPR-1	VPR-3	VPR-6
Length, mm	120	145	185
Ø, mm	40	40	47

Hydraulic symbol

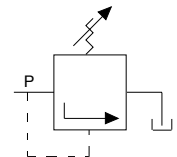

Pressure switch model VPS

Adjustable between 100 - 800 bar

As soon as the pressure has reached the set value, a micro-switch (altering contact) is activated.

This signal can be used:

- For automatic pressure limiting.
- To report a certain pressure value.
- As an automatic motor on/off switch with pressure guard power packs.

As soon as the pressure has reached the set value, a micro-switch (alternating contact) is activated. Should the pressure drop, the micro-switch starts the pump again in order to rebuild the pressure.

Manifolds model MY

700 bar

Manifolds are used when several hydraulic cylinders have to be connected to one hydraulic pump. All manifolds are equipped with 3/8 NPT inner oil ports, so that fittings, hydraulic hoses and couplers can easily be attached. To connect a manifold directly to a hand pump a FY-1 double nipple is recommended.

Each manifold is supplied with three steel blind plugs in case not all the oil ports are required.



Technical data model MY

Model	EAN-No. 4025092*	Oil ports	Weight kg
MY-1	*154789	6 x 3/8-NPT inner	0.5
MY-2	*154895	4 x 3/8-NPT inner	0.6
MY-4	*154833	7 x 3/8-NPT inner	1.4

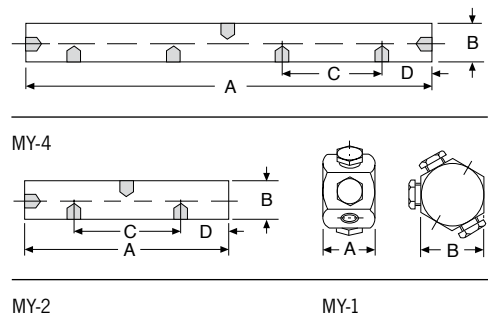

Dimensions model MY

Model	MY-1	MY-2	MY-4
A, mm	40	150	330
B, mm	50	40	40
C, mm	-	90	90
D, mm	-	30	30

Technical data model VPS

Model	EAN-No. 4025092*	Control range bar	Electric data	Oil ports	Difference of switch point bar	Repeat accuracy bar	Weight kg
VPS-1	*155090	100-800	5 A/250 V	3/8 NPT	25-70	10	0.5

Dimensions model VPS

Model	VPS-1
Dimensions, mm	130 x 85

Hydraulic symbol

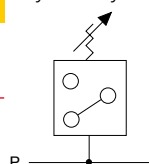



Manifolds model MY

With shut-off valve, 700 bar

Manifolds with shut-off valves are used when different pressures must be maintained in each hydraulic line and therefore allow the lifting of unequal loads. The manifolds are ready assembled and can be screwed directly to a hand pump or power pack. Depending on the way of assembly a short hose HHC-10 and a coupler half CFY-1 can be helpful.

Manifolds models MY ... GYA are equipped with the corresponding number of shut-off valves plus pressure gauge sets (GYA-63) which allow a permanent reading of each individual load.

Technical data model MY

Model	EAN-No. 4025092*	Description	Weight kg
MY-22	*155045	Manifold with 2 shut-off valves	1.8
MY-44	*155052	Manifold with 4 shut-off valves	3.7
MY-66	*159517	Manifold with 6 shut-off valves	5.5
MY-22-GYA	*159210	Manifold with 2 shut-off valves and 2 pressure gauges	2.8
MY-44-GYA	*159227	Manifold with 4 shut-off valves and 4 pressure gauges	5.7
MY-66-GYA	*159524	Manifold with 6 shut-off valves and 6 pressure gauges	8.5



Hand pump HPS - 2/2
with MY - 44



Electric hydraulic pump
PY - 07/3/20/3 M with VSM - 21 and MY - 44

Transportation box model HPK-10

For hand pumps, hydraulic cylinders and accessories

For easy transportation and protection of your valuable tools. Large enough to take a hand pump with pressure gauge and hydraulic hose plus several hydraulic cylinders.

The sturdy sheet metal box is equipped with a solid handle and two clasps.

Model HPK-10

Dimensions (L x W x H): 800 x 300 x 170 mm,

Weight: approx. 7.8 kg.



Hydraulic oil model HFY

For all hand pumps and power packs

The high quality of the Yale hydraulic oil guarantees a long service life for your equipment.

The high grade HLP oil has the following features:

Features

- Class of viscosity ISO VG 32.
- High lubrication index.
- High pressure resistance.
- Favourable temperature/viscosity index.
- Protection against corrosion and cavitation.
- Minimizes the formation of foam and sludge.
- Good derivation of temperature.
- No aging problems.
- Good compatibility with all sealing materials.
- Fulfills all requirements of the DIN 51524 part 2.



Technical data model HFY

Model	EAN-No. 4025092*	Content l
HFY-1	*156622	1
HFY-5	*156639	5
HFY-10	*159562	10
HFY-20	*159579	20



Pressure gauges model GGY

The use of pressure gauges is recommended when the operating pressure (the force of the connected cylinder) should be monitored. Yale pressure gauges are equipped with a stainless steel housing and an acrylic plastic face cover plate.

To absorb pressure shocks gauges are glycerine-filled, thus contributing to a long service life. Also, when fitted to a motor pump the pointer will stay jitter-free.

For the calculation of applied cylinder forces corresponding converting charts (pressure vs. force) can be supplied for all Yale hydraulic cylinders free of charge.

Technical data model GGY

Model	EAN-No. 4025092*	Pressure range bar	Scale diameter mm	Glycerine-damped	Oil port DIN 16288	Spanner size	Accuracy class %
GGY-631	*154796	0-1000	63	yes	G 1/4	14	1.6
GGY-632	*155120	0-1000	63	yes	1/4 NPT	14	1.6
GGY-633	*155274	0-160	63	yes	G 1/4	14	1.6
GGY-634	*155281	0-250	63	yes	G 1/4	14	1.6
GGY-635	*155298	0-400	63	yes	G 1/4	14	1.6
GGY-636	*155304	0-600	63	yes	G 1/4	14	1.6
GGY-1001	*154802	0-1000	100	yes	G 1/2	22	1.0
GGY-1001 SZ*	*155168	0-1000	100	yes	G 1/2	22	1.0
GGY-1004	*155151	0-700	100	yes	G 1/2	22	1.0
GGY-1005	*159203	0-160	100	yes	G 1/2	22	1.0
GGY-1002	*155137	0-250	100	yes	G 1/2	22	1.0
GGY-1003	*155144	0-400	100	yes	G 1/2	22	1.0
GGY-2500	*155113	0-2500	100	yes	G 1/2	22	1.6

*GGY-1001 SZ = with maximum pointer



Pressure gauge model GYA-63

Consisting of pressure gauge GGY-632 (diameter Ø 63 mm, glycerine-damped) and corresponding gauge adaptor. This pressure gauge set is suitable for connection to all HPS hand pumps.

Assembled ready to use, compact design with 45° inclination for easy reading.

Technical data model GYA

Model	EAN-No. 4025092*	Pressure gauge bar	Oil port pump	Oil port hose	Weight kg
GYA-63	*156103	0-1000 bar, Ø 63 mm, glycerine-damped	3/8-NPT outer	3/8-NPT inner	0.5

Pressure gauge adaptor model GA

Gauge connection with sleeve nut and 30° inclination for easy reading.

Suitable for all hand pumps series HPS.



Technical data model GA

Model	EAN-No. 4025092*	Oil port gauge	Oil port pump	Oil port hose
GA-700	*155557	G 1/4	3/8-NPT outer	3/8-NPT inner
GA-701	*155588	G 1/2	3/8-NPT outer	3/8-NPT inner

Pressure gauge adaptor model GA

For double-acting hand pumps model HPH, for the mounting between 4/2-directional valve and hand pump.

Features

- Advantage: shows both the pushing force and the pulling force of the connected hydraulic cylinder.
- 30° inclination for easy reading.
- Pressureless return line by means of the telescopic double nipple.



Technical data model GA

Model	EAN-No. 4025092*	Oil port gauge	Oil port	Telescopic nipple
GA-703	*155564	G 1/2	2 x 3/8-NPT outer	2 x 1/4-NPT outer
GA-704	*156172	G-1/4	2 x 3/8-NPT outer	2 x 1/4-NPT outer

Pressure gauge adaptor model GA-2000

This pressure gauge adaptor is suitable for connection to all TWAZ hand pumps (2000 bar). Suitable for pressure gauge GGY-2500.



Technical data model GA

Model	EAN-No. 4025092*	Max. operating pressure bar	Oil port gauge	Oil port pump	Oil port hose
GA-2000	*155915	2000	G 1/2	M22 x 1.5 outer (with seal cone)	M22 x 1.5 inner (for FY - 201)



Hydraulic couplers models CFY, CMY, CCY

Yale hydraulic couplers are selfsealing which means that the coupler halves only have to be closed hand tight. Both female and male parts have inner balls which seal the coupler halves in un-coupled condition, so that no hydraulic fluid will leak.

Please note that all Yale hydraulic cylinders are equipped with the standard female coupler half CFY-1 and dust cap CDF-9.

Technical data models CFY, CMY and CCY

Model	EAN-No. 4025092*	Description	Connection thread	Max. pressure bar
CFY-1	*155489	Coupler half, female (standard)	3/8-NPT, outer	700
CFY-2	*155960	Coupler half, female	3/8-NPT inner	700
CFY-18	*155922	Coupler half, female	M18 x 1,5 outer	700
CFY-10-S	*156400	Coupler half, female	Pipe Ø 10 mm	700
CMY-1	*155496	Coupler half, male	3/8-NPT, inner	700
CCY-1	*155472	Coupler halves, female + male	3/8-NPT	700
CDF-9*	*155885	Dust cap, rubber	-	-

*fits to female and male coupler halves (standard with all female coupler halves)

Dimensions models CFY, CMY and CCY

Model	CFY-1	CFY-2	CFY-18	CFY-10-S	CMY-1	CCY-1
A, mm	-	-	-	-	-	85
B, mm	72	78	72	72	-	-
C, mm	-	-	-	-	38	-
D, mm	35	35	35	35	-	-
E, mm	24	27	24	24	-	-
F, mm	-	-	-	-	32	-

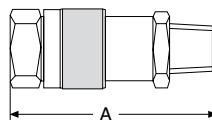

Coupler complete CCY-1

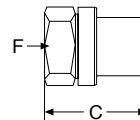

Coupler half, male CMY-1

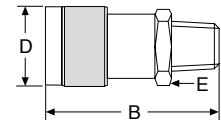

Coupler half, female CFY-1

Hydraulic couplers must always be completely closed, since otherwise the circulation cannot be released.

Hydraulic hoses model HHC

Durable but highly flexible thermoplast hydraulic hoses guarantee a very long life.

The 4-layer build-up includes 2 layers of high tensile steel fabric and robust fitting with 19 mm hexagon.

The volumetric expansion is very low. Hydraulic hoses model HHC...are equipped with a male coupler half as standard.

Standard length are as per the chart below, further lengths or hoses with larger diameters are quoted on request.



Technical data model HHC

Model	EAN-No. 4025092*	Length	Width	Operating pressure	Burst pressure	Connection 1 thread nipple 3/8-NPT, outer	Connection 2 male coupler half CMY-1	External diameter approx.	Min. bend radius	Width
		mm	mm	bar	bar			mm	mm	mm
HHC-5	*155786	0.5	6.3	700	2800			14	100	6.3
HHC-10	*155687	1	6.3	700	2800			14	100	6.3
HHC-20	*155380	2	6.3	700	2800			14	100	6.3
HHC-30	*155793	3	6.3	700	2800			14	100	6.3
HHC-40	*155397	4	6.3	700	2800			14	100	6.3
HHC-60	*155595	6	6.3	700	2800			14	100	6.3
HHC-80	*155731	8	6.3	700	2800			14	100	6.3
HHC-100	*155809	10	6.3	700	2800			14	100	6.3
HHC-120	*156370	12	6.3	700	2800			14	100	6.3
HHC-150	*156387	15	6.3	700	2800			14	100	6.3

How to order

Hydraulic hose for all standard combinations (- pump - hose - cylinder -):

Order a standard hose with female coupler half model HHC... (e.g. HHC-20).

Hydraulic hose for coupling connections on both sides (both ends with CMY-1):

Order a complete coupler CCY-1 in addition to a standard hose model HHC... (recommended for long hydraulic hoses).

Hydraulic extension hose

(one male coupler half, one female coupler half):

Order a female coupler half CFY-2 (inner thread) in addition to a standard hose model HHC.

Hydraulic hose without any coupler parts

(both ends with threaded nipples):

Order model HH... (both ends 3/8-NPT outer).











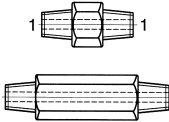

Fittings, reducers, connectors model FY

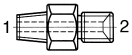
Fittings are useful for versatile combinations of hydraulic cylinders.



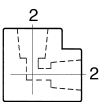

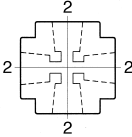

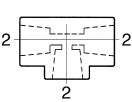



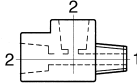

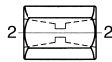

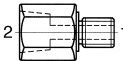

Yale high pressure fittings have been designed to give a variety of connections, extensions and combinations. The fittings are designed for a max. system pressure of 700 bar.

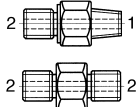
For improved sealing of 3/8 NPT connections use 2 layers of teflon tape and tighten accordingly.

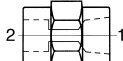
Technical data model FY

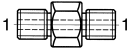
Model	EAN-No. 4025092*		Description	Figures	Connection 1	Connection 2
FY-1 FY-1L	*155403 *156219		Double nipple Double nipple, long		3/8 NPT outer 3/8 NPT outer	- -
FY-13 FY-17 FY-18	*155656 *155816 *155823		Double nipple		1/4 NPT outer 3/8 NPT outer 3/8 NPT outer	R 1/4 outer M14 x 1.5 (for sleeve nut) R 1/4 outer
FY-2	*155410		Elbow		3/8 NPT outer	3/8 NPT inner
FY-3	*155427		Elbow		-	3/8 NPT inner
FY-6	*155458		Cross		-	3/8 NPT inner
FY-4	*155434		Tee		-	3/8 NPT inner

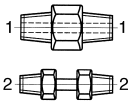
Technical data model FY

Model	EAN-No. 4025092*		Description	Figures	Connection 1	Connection 2
FY-5	*155441		Tee		3/8 NPT outer	3/8 NPT inner
FY-7 FY-11	*155465 *155649		Connection		-	3/8 NPT inner 1/4 NPT inner
FY-8 FY-9	*155540 *155632		Adaptor		3/8 NPT outer 1/4 NPT outer	R 1/2 inner 3/8 NPT inner
FY-10 FY-12	*155663 *155670		Adaptor		3/8 NPT outer 1/2 NPT outer	1/4 NPT inner 3/8 NPT inner
FY-16 FY-19 FY-20 FY-30 FY-33	*155748 *155830 *155847 *156318 *156592		Adaptor		3/8 NPT outer M18 x 1.5 outer M14 outer G 3/8 outer 3/8 NPT outer	M18 x 1.5 inner 3/8 NPT inner 3/8 NPT inner 3/8 NPT inner M14 x 1.5 inner
FY-26 FY-27	*156196 *156202		Double nipple		3/8 NPT outer G 3/8 outer	G 3/8 outer G 3/8 outer
FY-31 FY-32	*156325 *156332		Connection		3/8 NPT inner 3/8 NPT inner	M18 x 1.5 inner M20 x 1.5 inner
FY-35	*156608		Double nipple		M 14 outer	-
FY-703	*155571		Connecting set for 4/3-way valve to HPS hand pumps (telescopic nipple)		3/8 NPT outer	1/4 NPT outer
FY-201	*156011		Hose connector for TWAZ hand pumps 2000 bar		R1/4 outer	M22 x 1.5 outer (with seal cone)



Hydraulic puller with integrated hydraulics model BMZ

Max. pulling force 6, 8 and 11 t

Hydraulic pullers are an invaluable tool for the maintenance engineer. The pullers allow time and cost savings as they offer high working safety and can be operated in all positions. Hydraulic pullers are used in all kinds of industries, workshops and in many repair and assembly jobs to remove or install interference fit parts, such as: gears, couplings, bearings, wheels, pulleys, axles, shafts, break drums and many other press fit components. Damage to parts is minimized through the use of controlled hydraulic power, whilst machine down-time can be reduced drastically.

Features

- Drop-forged alloy steel jaws.
- Hard chromium plated piston, spring return.
- No radial moment of torsion.
- No spindle wear.
- Integrated hydraulic cylinder and pump.
- Quick adjustment with trapezoid speed nut.
- 3 and 2-jaw design.
- Pump lever can rotate through 360°.
- Piston with durable, spring loaded centering tip.
- Supplied in a sturdy plastic box.

Technical data model BMZ

Model	EAN-No. 4025092*	Max. pulling force t	Piston stroke mm	Weight kg
BMZ-6	*154499	6	82	4.9
BMZ-8	*154505	8	82	6.6
BMZ-11	*154512	11	82	8.0

Dimensions model BMZ

Model	BMZ-6	BMZ-8	BMZ-11
Reach max. A, mm	160	200	230
Diameter Ø B, mm	200	250	280
Length C, mm	320	320	345

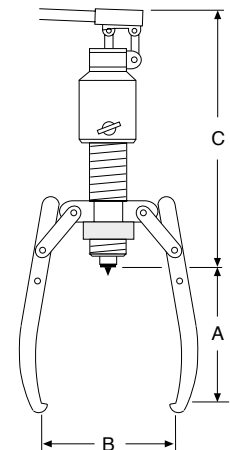

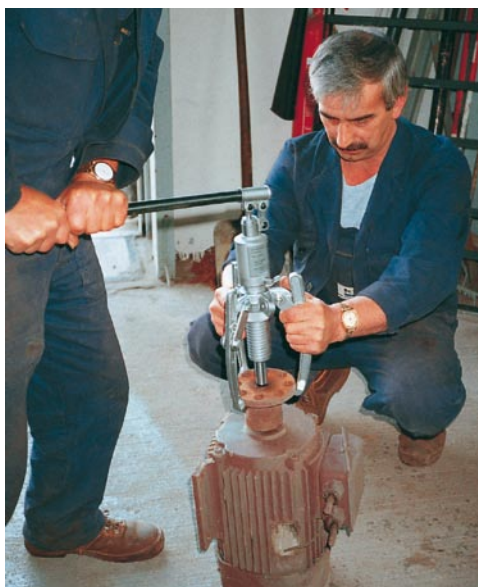

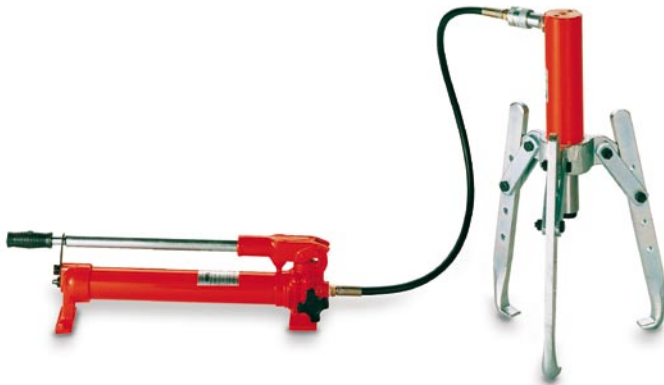

Puller sets with separate hydraulics 10, 15 and 23 t model BMZ

Max. pulling force 10 - 23 t

The harder the pulling force, the tighter the grip of the jaws. Longer jaws up to 1000 mm are available on request.

Features

- High quality components from our standard hydraulic program.
- Modular system, hydraulic parts can also be used for many other applications.
- Long-life hydraulic cylinders manufactured from chromium-molybdenum steel.
- Two-stage quick-action hand pumps.
- Incl. high pressure hydraulic hose with quick coupler, L = 2 m.
- All complete sets are supplied in metal box model HPK-10 or wooden case.
- All sets are supplied ready to use.

Scope of delivery

Pressure gauge set model GYA-63.



Accessories for BMZ-2311: BMZ-2308 extensions of pulling arms increase the reach (A) up to 400 mm. Model BMZ-2309 up to 500 mm.



Pressure gauge set model GYA-63 is part of the scope of delivery.

Model BMZ-1000 and 1510

The harder the pulling force, the tighter the grip of the jaws. Longer jaws up to 1000 mm are available on request.

Model BMZ-2311

The radially adjustable pulling arms can be locked at any position.

Technical data model BMZ

Model	EAN-No. 4025092*	Max. pulling force t	Hydraulic cylinder model	Hand pump model	Hydraulic hose model	Lift of the cylinder mm	Weight kg
BMZ-1000	*154529	10	without	without	without	–	9.5
BMZ-1010	*154536	10	with YS-10/150	with HPS-2/0.7 A	HHC-20	150	21.5
BMZ-1500	*154543	15	without	without	without	–	9.5
BMZ-1510	*154550	15	with YS-15/150	with HPS-2/0.7 A	HHC-20	150	23.5
BMZ-2300	*154567	23	without	without	without	–	28.0
BMZ-2311	*154482	23	with YS-23/160	with HPS-2/0.7 A	HHC-20	160	45.0

Dimensions model BMZ

Model	BMZ-1000	BMZ-1010	BMZ-2300
Reach max. A, mm	300	300	300
Diameter Ø B, mm	350	350	350

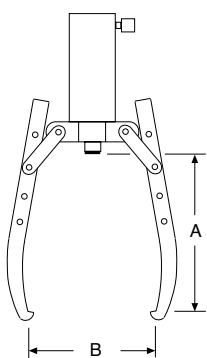

Models BMZ-1010 and BMZ-1510

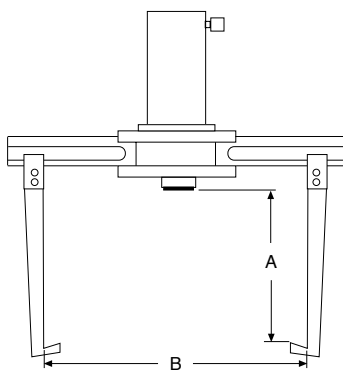

Model BMZ-2311

Hydraulic puller set model YHP

Max. pulling force 20, 30 and 50 t

These professional puller sets are designed for removing and installing press fitted or heat fitted parts. Hydraulic puller sets eliminate time-consuming and costly repairs as they avoid the damage of parts and reduce machine down times. All parts are manufactured from high quality dropforged steel.

Scope of delivery

The complete sets are supplied ready to use and include all necessary components such as hollow cylinder, hydraulic hand pump, pressure gauge (to control the pulling force) and 2 meter hydraulic hose with quick connect coupler.



3-Grip puller sets

For all pulling jobs where solid parts have to be removed, e.g. gears, belt pulleys, sprockets, flywheels, couplers, shafts, axles etc. The sets can be used as both 3-jaw and 2-jaw puller.

Model	EAN-No. 4025092*	Max. pulling force t
YHP-252 G	*161992	20
YHP-352 G	*162005	30
YHP-552 G	*162012	50



Crosshead puller sets

For all pulling jobs where multi-segmented parts have to be removed like: Ball bearings, roller bearings and similar parts. Puller sets are supplied complete with bearing puller attachment and bearing cup puller.

Model	EAN-No. 4025092*	Max. pulling force t
YHP-262 G	*162029	10
YHP-362 G	*162036	20
YHP-562 G	*162043	25



Multi-purpose puller sets

These multi-purpose puller sets are universal combinations from both a.m. sets and include all necessary parts from 3-grip puller set and crosshead puller set.

Model	EAN-No. 4025092*	Max. pulling force t
YHP-2752 G	*161787	20
YHP-3752 G	*161824	30
YHP-5752 G	*162050	50

Type of puller set

Model	3-grip puller set			Crosshead puller set			Multi purpose puller set		
	YHP-252 G	YHP-352 G	YHP-552 G	YHP-552 G	YHP-362 G	YHP-562 G	YHP-2752 G	YHP-3752 G	YHP-5752 G
EAN-No. 4025092*	*161992	*162005	*162012	*162029	*162036	*162043	*161787	*161824	*162050
Capacity, t	20	30	50	20	30	50	20	30	50
Hand pump, model HPS-1/07 A (part 1)	•	•	–	•	•	–	•	•	–
Hand pump, model HPS-2/2 A (part 1)	–	–	•	–	–	•	–	–	•
Pressure gauge set, model GYA-63 (part 2)	•	•	•	•	•	•	•	•	•
Hydraulic hose, model HHC-20 (part 3)	•	•	•	•	•	•	•	•	•
Hollow cylinder (part 4), model	YCS-21/50	YCS-33/60	YCS-57/70	YCS-21/50	YCS-33/60	YCS-57/70	YCS-21/50	YCS-33/60	YCS-57/70
Crosshead, 3-grip (part 5)	•	•	•	–	–	–	•	•	•
Crosshead, 2-grip (part 6)	•	•	•	–	–	–	•	•	•
Grip arm, 3 pcs. (part 8)	•	•	•	–	–	–	•	•	•
Spindle (part 9)	•	•	•	•	•	•	•	•	•
Strap, 6 pcs. (part 10)	•	•	•	–	–	–	•	•	•
Strap screws + strap nuts, 6 pcs. (part 11)	•	•	•	–	–	–	•	•	•
Mounting screws, 2 pcs. (part 13a)	•	•	•	–	–	–	•	•	•
Mounting screws, 2 pcs. (part 13b)	–	–	–	•	•	•	•	•	•
Saddle with internal thread (part 14)	•	•	•	•	•	•	•	•	•
Smooth saddle (part 15)	•	•	•	•	•	•	•	•	•
Crosshead (part 16)	–	–	–	•	•	•	•	•	•
Slide plate, 2 pcs. (part 17)	–	–	–	•	•	•	•	•	•
Nut, 2 pcs. (part 18)	–	–	–	•	•	•	•	•	•
Washer, 2 pcs. (part 19)	–	–	–	•	•	•	•	•	•
Pulling leg, short, 2 pcs. (part 20), mm	–	–	–	280	255	455	280	255	455
Pulling leg, long, 2 pcs. (part 21), mm	–	–	–	460	505	773	460	505	773
Leg end, 2 pcs. (part 24)	–	–	–	•	•	•	•	•	•
Leg connector, 2 pcs. (part 25)	–	–	–	•	•	•	•	•	•
Bearing puller attachment (part 26)	–	–	–	•	•	•	•	•	•
Bearing cup pulling attachment (part 27)	–	–	–	•	•	•	•	•	•
Storage case (part 29)	•	•	•	•	•	•	•	•	•
Weight, kg	40	65	120	46	86	156	91	172	295

The symbols stand for: • included complete set, – not included

Dimensions hydraulic puller set model YHP

Model	20 t	30 t	50 t
3-grip A, mm	300	520	700
C, mm	0 - 817	0 - 977	0 - 1233
3-grip B, mm	500	900	1200
D, mm	25 - 155	30 - 250	75 - 330
2-grip A, mm	300	520	700
E, mm	152	250	330
2-grip B, mm	420	700	1000
F, mm	140	150	150
G, mm	30 - 180	75 - 230	75 - 230

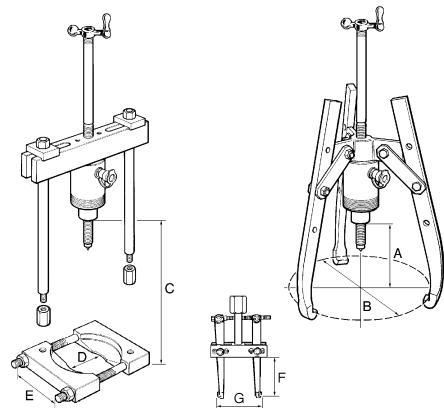



Yale Aluminium hydraulic jacks model AJH and model AJS

Capacities from 6.5 - 100 t

Aluminium jacks combine light weight with high lifting capacity. The use of high tensile aluminium alloy allows lifting capacities of up to 100 tons resulting in a very favourable 1.8 tons lifting capacity per 1 kg weight ratio. Operation of Yale hydraulic jacks is very simple. Jacks are supplied ready for use, i.e. including hydraulic oil, operating lever and, where applicable, carrying handle and lifting claw.

Aluminium jacks with lifting claw

Jacks from 20 tons are available with a lifting claw. In this case the jacks are provided with an elongated base plate. The max. permissible working load of the lifting claws is 40 % of the jack capacity.

Aluminium jacks with safety lock nut

Jacks from 20 tons can be supplied with a safety lock nut. This device allows absolute safe jacking over a long period. In this case the hydraulic jack can operate like a mechanical support and the hydraulic system can be totally released.

Application

Yale hydraulic jacks are universally popular tools for use in workshops or on site for all kinds of lifting and assembly applications, for construction, ship building, power plants, general engineering, metal fabrication and many more. Applications are unlimited. Standard jacks with plain piston and jacks with safety lock nuts cannot be used with a lifting claw. To increase stability, all jacks with long stroke (305 mm) are equipped with an elongated base plate.

Features

- Strokes from 75 to 305 mm.
- Extremely low weight.
- The 6.5 and 10 tons jacks can be operated in any position (also upside down) and are equipped with spring return piston and stop ring.
- The 20 to 100 tons jacks can be operated vertically or front face horizontally.
- All jacks are provided with an overload protection valve.
- From 20 tons capacity with additional mechanical stroke limiter.
- All jacks with hardened alloy steel saddle and sensitive lowering valve which is activated by the operating lever.



Back view AJH-620 SR

Technical data model AJH and model AJS

Jacks with plain piston (standard type)

Model	EAN-No. 4025092*	Capacity t	Max. capacity of lifting claw t	Lift mm	Overall height mm	Base plate mm	Min. height of lifting claw mm	Weight kg
AJS-65	*157995	6.5	–	75	131	159 x 76	–	3.6
AJS-104	*158015	10	–	115	182	171 x 76	–	6.3
AJH-620	*158046	20	–	152	265	180 x 120	–	10.9
AJH-1220	*158107	20	–	305	440	250 x 120	–	16.7
AJH-630	*158169	30	–	152	265	200 x 140	–	15.4
AJH-1230	*158220	30	–	305	452	275 x 140	–	23.4
AJH-660	*158282	60	–	152	293	250 x 190	–	27.4
AJH-1260	*158343	60	–	305	500	340 x 190	–	43.7
AJH-6100	*158404	100	–	152	315	305 x 250	–	49.0

Jacks with lifting claw

Model	EAN-No. 4025092*	Capacity t	Max. capacity of lifting claw t	Lift mm	Overall height mm	Base plate mm	Min. height of lifting claw mm	Weight kg
AJH-620 C	*158060	20	8	152	280	250 x 120	67	14.5
AJH-1220 C	*158121	20	8	305	452	250 x 120	67	22.2
AJH-630 C	*158183	30	12	152	284	275 x 140	72	20.3
AJH-1230 C	*158244	30	12	305	472	275 x 140	72	31.0
AJH-660 C	*158305	60	24	152	327	340 x 190	72	43.1
AJH-1260 C	*158367	60	24	305	533	340 x 190	72	64.9

Jacks with safety lock nut

Model	EAN-No. 4025092*	Capacity t	Max. capacity of lifting claw t	Lift mm	Overall height mm	Base plate mm	Min. height of lifting claw mm	Weight kg
AJH-620 SR	*158084	20	–	152	291	180 x 120	–	10.9
AJH-1220 SR	*158145	20	–	305	464	250 x 120	–	16.7
AJH-630 SR	*158206	30	–	152	294	200 x 140	–	15.4
AJH-1230 SR	*158268	30	–	305	480	275 x 140	–	23.4
AJH-660 SR	*158329	60	–	152	330	250 x 190	–	27.4
AJH-1260 SR	*158381	60	–	305	536	340 x 190	–	43.7
AJH-6100 SR	*158428	100	–	152	366	305 x 250	–	53.0



Universal jacks model JH

Capacity from 2 - 50 t

Yale universal jacks supply high forces for general operations like lifting, pushing, moving, supporting of all kind of loads.

Features

- Robust, long life design.
- Pressure relief valve.
- Precise controlled lowering.
- Additional screw extension of the piston (from 2 - 20 t).
- Grooved saddle.
- Large base plates for increased stability.
- Model JH-50-2 with two-stage pump.
- Incl. operating lever.



Model JH-50-2

Technical data model JH

Model	EAN-No. 4025092*	Capacity t	Lift mm	Additional screw extension mm	Closed height mm	Base plate mm	Pump	Weight kg
JH-2 A	*162722	2	115	50	181	90 x 95	1 st stage	2.7
JH-4 A	*162739	4	126	60	205	115 x 110	1 st stage	3.7
JH-6 A	*162746	6	130	75	219	115 x 110	1 st stage	4.7
JH-8 A	*162753	8	152	70	225	120 x 120	1 st stage	5.7
JH-12 A	*162760	12	153	80	240	140 x 130	1 st stage	8.0
JH-20 A	*162777	20	153	80	240	160 x 155	1 st stage	11.0
JH-30	*154352	30	180	–	280	210 x 180	1 st stage	22.0
JH-50-2	*154376	50	178	–	305	255 x 190	2 nd stage	53.0

Machine jacks with lifting claw model YAM

Capacity 2 - 15 t

Machine jacks with lifting claw are used in applications where space below the load is restricted, thus preventing the use of traditional lifting equipment.

Typical applications for machine jacks are lifting, positioning and transportation of machines, heavy steel constructions or similar loads, as well as general repair and assembly applications.

The jacks are also useful for applications like leveling of high-rise warehouses, heavy duty scaffolds, large frameworks etc.

Features

- Offers safe lifting of machines with an extremely low clearance.
- Incl. safety pressure valve to prevent overload.
- Large base offers increased stability under load.
- Pump lever can rotate through 270° (excluding YAM-2).
- Same load can be lifted on either the head or the claw of jack.
- Spring return of the lifting claw (excluding YAM-2).
- Precision adjustable lowering valve.
- Jacks are supplied ready to use incl. pump lever and are filled with oil.



YAM-10

YAM-5



YAM-2

YAM-15

Technical data model YAM

Model	EAN-No. 4025092*	Capacity on the claw t	Lift mm	Weight kg
YAM-2	*157711	2	113	8
YAM-5	*153997	5	120	19
YAM-10	*154000	10	145	38
YAM-15	*157728	15	140	41

Dimensions model YAM

Model	YAM-2	YAM-5	YAM-10	YAM-15
A, mm	235	290	325	336
B, mm	180	257	280	292
C, mm	125	182	240	240
D, mm	50	75	100	85
E, mm	50	57	60	60
F, mm	85	117	150	110
G, mm	16	22	28	28

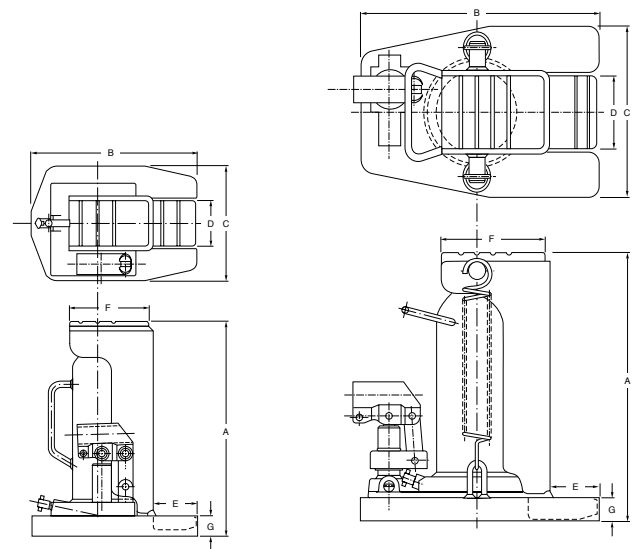

Model YAM 2

Model YAM 5 to YAM 15

Hydraulic machine jacks model YAP

Capacity 5 - 50 t

Hydraulic machine jacks are designed for the safe lifting and positioning of machines and similar heavy equipment.

Features

- These jacks are operated with external pumps, e.g. hand or motor pumps but also with synchronous power packs.
- The compact construction allows operation even in extremely confined areas.
- 3 hook-in positions of the lifting claw provide high flexibility (model YAP-5130 4 hook-in positions).
- The load can be lifted with either the lifting claw or with the head of the jack.
- Welded, distortion proof steel construction.
- High quality, durable hydraulic components.
- The flat lifting claw allows low jacking height.
- Safe stability due to swivel-mounted support feet.
- Operation of the jack requires the usage of a manometer for pressure/power control.
- The connection between jack and pump is made by a hydraulic hose.
- The jacks are delivered ready-to-use inclusive of carrying handles and coupling half.



Technical data model YAP

Model	EAN-No. 4025092*	Capacity t	Lift mm	Min. height for applications in mm	Max. pressure bar	Weight approx. kg
YAP-5130	*160018	5	133	15	700	13.5
YAP-10150	*160025	10	155	20	700	23.0
YAP-15150	*160032	15	155	25	700	40.0
YAP-25150	*160049	25	155	30	700	60.0
YAP-50150	*160056	50	155	35	700	165.0

Dimensions model YAP

Model	YAP- 5130	YAP- 10150	YAP- 15150	YAP- 25150	YAP- 50150
A min., mm	15	20	25	30	35
A max., mm	232	273	291	300	375
B, mm	228	277	328	387	540
H, mm	252	283	316	330	405
L, mm	161	194	245	278	375

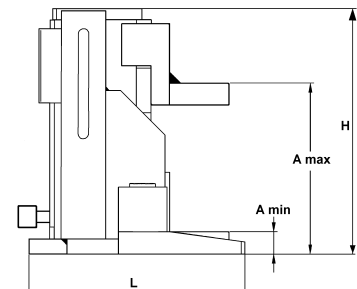
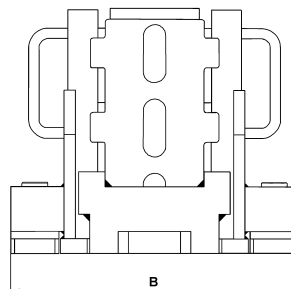

Hydraulic machine jacks model YAS

Capacity 3 - 25 t

Hydraulic machine jacks are designed for the safe lifting and positioning of machines and similar heavy equipment.

Features

- Integrated hydraulic pump.
- Pump lever swivel mounted 270° for operation even in extremely confined areas.
- Same load can be lifted on either the head or the claw of jack.
- Welded, distortion proof steel construction.
- High quality, durable hydraulic components.
- The flat lifting claw allows low jacking height.
- The additional connect coupler for external pump operation allows connection of hand, motor or synchronous lifting pumps (excluding YAS-3 and YAS-5).
- Safe stability due to swivel-mounted support feet.
- Sensitive lowering valve for slow lowering of loads without jerks.
- When operating the jack with an external pump the installation of a manometer is mandatory.
- The integrated hydraulic pump is protected by a pressure limiting valve.
- The jacks are delivered ready-to-use inclusive of carrying handles, hydraulic oil filling and pump lever.



Technical data model YAS

Model	EAN-No. 4025092*	Capacity t	Lift mm	Min. height for applications in mm	Max. pressure bar	Weight approx. kg
YAS-3	*160063	3	140	12	520	15.0
YAS-5	*160070	5	140	15	520	19.0
YAS-10	*160087	10	140	20	520	28.0
YAS-15	*160094	15	140	25	520	50.0
YAS-25	*160100	25	140	30	520	72.0

Dimensions model YAS

Model	YAS-3	YAS-5	YAS-10	YAS-15	YAS-25
A min., mm	12	15	20	25	30
A max., mm	230	232	300	291	300
B, mm	207	228	277	328	387
H, mm	250	252	252	316	330
L, mm	198	216	271	345	388

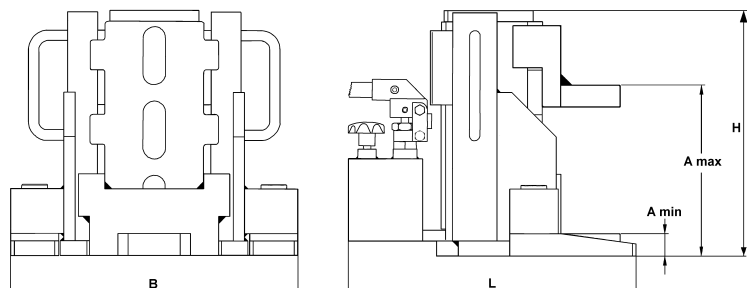



Hydraulic stage lifts model ST

Capacities up to 200 t

Compact, low-headroom and universal applications. Stage lifts are hydraulic lifting devices which are designed to lift and lower loads over high distances.

Stage lifts overcome the usual limitations of their lifting height imposed by stroke length. Stage lifts operate with „double-acting“ hydraulic cylinders (return stroke by hydraulic pressure) and are equipped with a load spreading plate and a piston support plate.

Operation

A stage lift operates inverted and lifts the load via the bottom of the cylinder whilst it climbs on a pile of support bars (wood or aluminium). In principle the load can be lifted to any height although stage lifts are still compact and versatile for low headroom lifting applications.

The simple „3-step operation“ eliminates the need for additional holding arrangements and the repositioning or replacing of cylinders which are normally required for a higher lifting distance. A stage lift climbs up and down on its own.

Control

Depending on the power pack, selected stage lifts can be controlled individually (by hand or motor pump) or together in a synchronized arrangement with multi-flow pumps.

Features

- Yale ChroMo-Design.
- Low cost lifting systems possible, (3-point resp. 4-point).
- Low weight (e.g. 60 kg for a 50 t unit).
- Stage lift body made from high grade aluminium.
- Hydraulic cylinders are designed from robust chromium-molybdenum steel with double bronze bearings ensure a longlife service system.
- Large diameter tilt saddle.
- Incl. coupler halves and carrying handles on request.

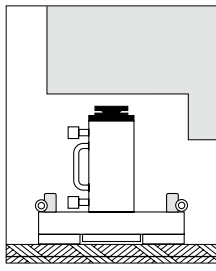

1. Stage: Initial position, stage lift rests on the ground under the load.

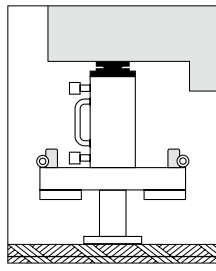

2. Stage: Step 1, load is raised.

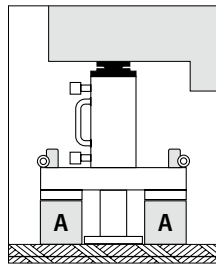

3. Stage: Two support bars type „A“ are positioned in place.

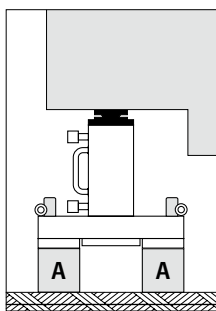

4. Stage: Piston is retracted and load rests on support bars type „A“.

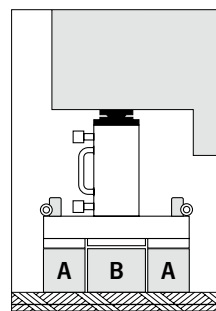

5. Stage: Broader middle bar type „B“ is inserted.

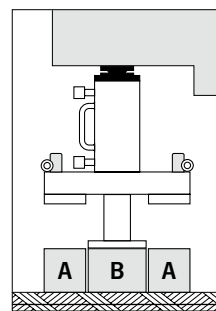

6. Stage: Step 2, load raised on broader middle bar „B“.

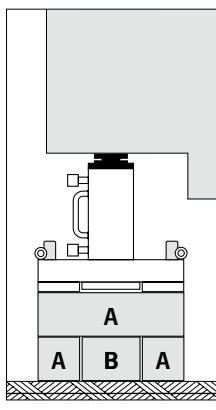

7. Stage: Two bars „A“ are inserted and rotated at 90°, piston is retracted and middle bar is inserted.

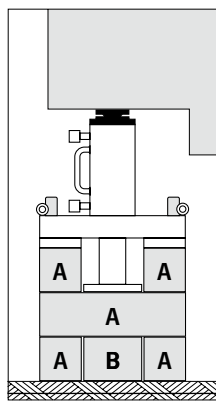

8. Stage: Load is lifted on middle bar (3rd step), two support bars type „A“ are positioned at 90° and load rests on support bars „A“.

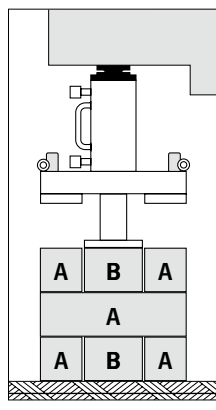

9. Stage: Piston is retracted, middle bar type „B“ is inserted and lifts the 4th step on middle bar „B“ and so on...

Technical data model ST

Model	EAN-No. 4025092*	Capacity stroke max. t	Lift mm	Overall height mm	Load spreading plate Ø mm	Piston plate Ø mm	Weight approx. kg
ST-5015	*157810	5	150	396	425 x 425	160	60
ST-10015	-	10	150	455	525 x 525	180	115
ST-20015	-	20	150	510	600 x 600	210	196

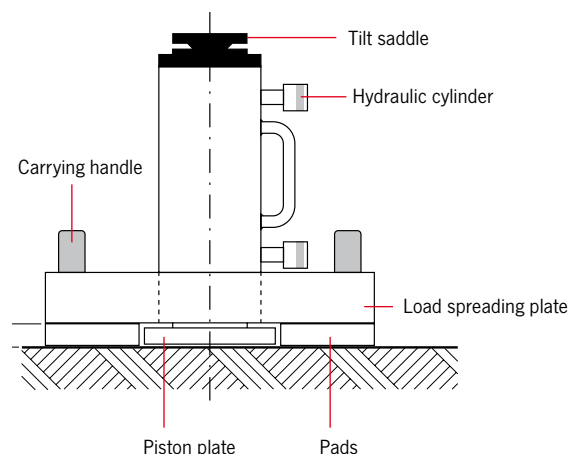



Hydraulic spreader model YHS

Max. capacity 0.5 - 1.5 t

These universal power tools can be used for all repair, maintenance and assembly work requiring precisely controlled power, e.g. aligning of containers and shells, lifting, positioning or aligning of machinery and structural components, forcing-off of shutterings and moulds. Applications are unlimited ...

The spreaders can be operated with all hand pumps.

Features

- Operating pressure max. 700 bar.
- Single-acting with spring return.
- Works in all positions.
- Spreader arms from high tensile steel.
- Incl. female coupler half CFY-1 with dust cap.

Technical data model YHS

Model	EAN-No. 4025092*	Capacity max. kN	Capacity max. t	Max. operating pressure bar	Oil volume max. cm ³	Spread width min. mm	Spread width max. mm	Weight kg
YHS-05	*157650	5	0.5	700	10	16	100	1.9
YHS-11	*154741	10	1.0	700	10	14	100	2.1
YHS-15	*154673	15	1.5	700	70	35	220	6.9



Hydraulic chain cutter model YCC-1.2

This hydraulic chain cutter has been designed for cutting high tensile, grade 8 chains up to a material diameter of 13 mm. The open design allows easy positioning of the chain. The unit can be operated using the standard hand or motor pumps, e.g. mini hydraulic pumps: Model PAY-6, electric power packs: Model PY-04/2/5/2 M, hand pump: Model HPS-2/0.7A.

Features

- Operating pressure max. 700 bar.
- Max. cutting force: 23 t.
- Cutting performance: 13 mm Ø (chain grade 8).
- Max. opening of blades: 30 mm.
- Dimensions (L x W x H): 310 x 140 x 180 mm.
- Weight: 17 kg.
- Built-in standard hydraulic cylinder.
- Single-acting with spring return.
- Durable, heat treated cutting blades easy replacement, blades can be re-sharpened.
- Also useable for cutting full material.
- Highly secured working through protection guard.
- Ready to use, includ. coupler-half, female.

Hydraulic propeller press system model PPS

Max. operating pressure 2000 bar

The Yale hydraulic propeller press system is used to press-fit large propellers onto the drive shaft of ships. To this end the special flat cylinders can be linked together to build a chain of any length and press force. The cylinders are provided with appropriate link eyes at both sides.

The max. operating pressure of 2000 bar ensures high pressure forces up to 1600 t or more.

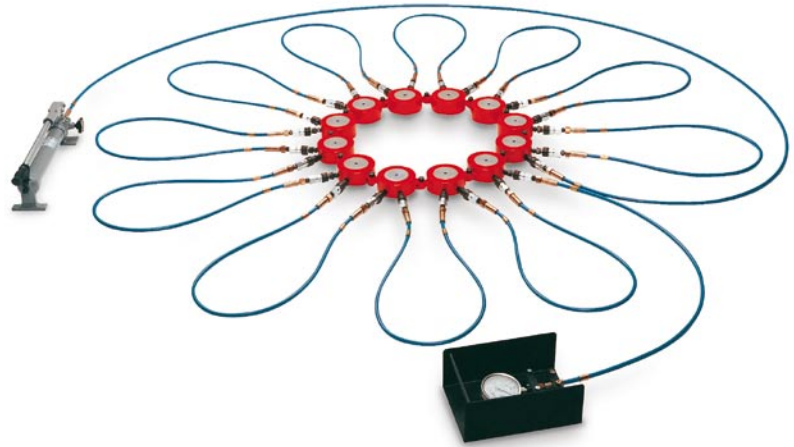

A complete hydraulic propeller press system with 12 cylinders with a total capacity of 1200 tons. The system is complete with appropriate connecting hoses with quick release couplers, pressure gauge up to 2500 bar and hand pump model TWAZ-2.3. All parts are designed for a maximum operating pressure of 2000 bar.

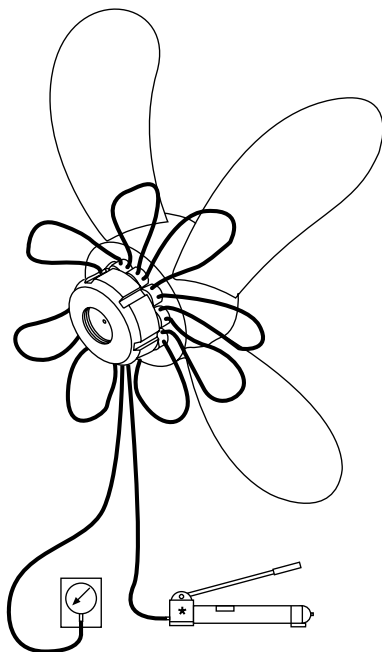

Special flat hydraulic cylinder

With link connections at both sides and 2 male quick connect coupler halves

Capacity, max.: 100 t.

Stroke 10 mm.

Pressure, max.: 2000 bar.

Diameter Ø: 127 mm.

Closed height: 50 mm.



Link plates and lifting hooks

They are used to connect the cylinders and to handle the complete chain with a crane. 2 pieces of link plates and lifting hooks as well as the corresponding number of high pressure hoses (with female quick connect couplers at both ends) belong to a complete set.



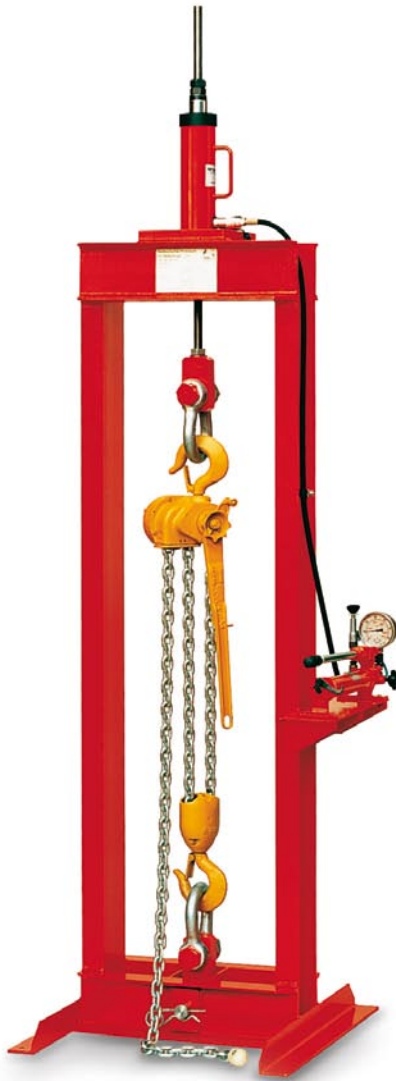

Hydraulic test rig for hoisting equipment model RPYS-1215

Max. capacity 12 t

For testing pul-lifts, lever hoists, chain blocks, wire rope pullers as well as other lifting equipment after repair or inspection.

Testing of hoisting equipment

The lifting unit is placed between upper and lower shackle, the chain is tensioned against the oil cushion of the partly advanced piston of the hydraulic cylinder. The applied force can be read on the pressure gauge.

Testing of the hoist brake

For a functional test of the hoist brake the hand pump may be used to apply a counter pressure and thus increase the pulling force after a general test.

Frequent use

For frequent testing, the hand pump may be replaced by a low-cost air hydraulic (model PAY-6) or electric pump (model PY-04/2/5/2 M).

Pressure gauge

To read-off the pulling forces more easily, the test rig is equipped with two high quality pressure gauges.

The pressure gauges are because of the quick-couplers easy to replace.

Pressure gauge 1 for small test items:

Model: GGY-1005,
display: 0-160 bar, Ø 100 mm, Kl. 1.0%

Pressure gauge 2 for big test items:

Model: GGY-1003,
display: 0-400 bar, Ø 100 mm, Kl. 1.0%

Mounted hollow cylinder model YCS-21/150

Single-acting, with spring return

Chromium-molybdenum steel, heat treated with bronze bearings.

Pressure-/pulling force: 120 kN (12 t).

Operating pressure: 0 - 400 bar.

Center hole Ø: 27 mm.

Mounted hydraulic hand pump model HPS-2/0.7A

Two-stage, with quick action

Operating pressure: 0 - 400 bar.

Reservoir: 0.7 l.

Fine-adjustment pressure relief valve.

Features

- Fully welded, low-strain press-frame.
- Upper and lower hook suspension by means of shackles, incl. two 5 tons pull-rings for smaller test units.
- Lateral pump table.
- Infinite adjustment of the pulling force.
- Chart for easy determination of test force.
- Removable lower suspension e.g. for testing of plate clamps.
- Base pre-drilled for mounting.
- Quality hydraulic components.
- Hollow cylinder made from chromium-molybdenum steel, heat-treated, inside and outside with dirt wipers.
- Long cylinder stroke of 150 mm, piston hardchromium-plated with bronze bearings.
- High-strength threaded bar (M27).
- Two-stage quick action hand pump.
- Fine-adjustment pressure valve.

Technical data model RPYS

Model	EAN-No.
RPYS-1215	4025092* *157469

Dimensions model RPYS

Model	RPYS-1215
A, mm	2580 - 2730
B, mm	2160
C, mm	1840
D, mm	500
E, mm	630
F, mm	760
G, mm	1030 - 1425
H, mm	750
J*, mm	150
Weight, kg	225

*700 mm with 5 t pull-rings

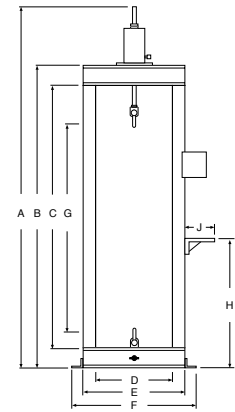

! The test rigs are delivered complete and ready to use.



Hydraulic test rig for steel winches model RPYS-1535

Max. capacity 15 t

For the testing of steel winches or similar lifting devices we offer a specific test rig.

Features

- Max. capacity 15 t.
- With hydraulic cylinder model YS-15/350.
- Stroke: 350 mm.

Scope of delivery

- Incl. two stage hand pump model: HPS-2/2 A.
- Fine-adjustment pressure valve 0-700 bar.
- Hydraulic hose 2 m, model: HHC-20.
- Pressure gauge model: GGY-1004, display: 0-700 bar, Ø 100 mm, Kl. 1.0 %.



RPY 10 to 23 t

Universal workshop presses model RPY and model RPES

10 - 200 t

For all repair and assembly jobs.

According to European standards, all Yale workshop presses can be used without any additional protection devices as the piston speed is below 10 mm/sec.

For special applications additional safety equipment (e.g. protection grid or two-hand-safety-control) can be offered on request.

Features

- Pressing and removing of bolts, shafts, bearings.
- Straightening of beams, profiles, axles, shafts.
- Forming, bending, crimping.
- General load tests and tests of weld specimens.
- Stamping, cutting, punching.
- Pre-adjustment of tools.

Equipment of all presses

Features

- All workshop presses are ready to use, including hydraulic oil, oil level gauge.
- High pressure - hydraulic hoses.
- Glycerine-damped pressure gauges.
- Fixing holes in base profiles, adjusting device for press table and head, swivelling pump console, conversion chart:
Pressure - force etc.

Description of the hydraulic cylinders

Features

- Cylinders made from chromium-molybdenum steel, heat treated and with metric mounting threads equipped in the piston.
- Double bronze bearing of the hard chromium plated piston.
- Piston return through spring or hydraulically.
- Mounting thread in the piston.
- Available piston strokes from 150 to 500 mm.

Description of the press-frame

Features

- Robust, torsion resistant construction.
- Massive, precise welded press-frames.
- Open construction, easily accessible from all sides.
- 50 and 100 tons workshop presses with adjustable press table and press head (frames for adjustments are part of the delivery package).
- 200 t press with adjustable table and fix welded press head.
- Four locking bolts ensure a precisely aligned press head and press table and increase the stability of the frame (50 and 100 t).
- 50, 100 and 200 t presses with pivoting pump table with peripheral passage for straightening of exceptionally long parts.
- Modular system: Further comprehensive combinations of hydraulic cylinders and pumps are possible.
- The drive is energized either through hand or electric hydraulic pumps.



RPY 50 to 200 t

Description of the hand pumps

Features

- All hand pumps with two-stage displacement.
- Glycerine-damped pressure gauge, $\varnothing 63$ mm, class 1.6%.
- Hydraulic hose, L = 2.0 m with male coupler half.

Description of the hydraulic power packs

Features

- Longlife radial piston pumps, from 50 t with two-stage displacement.
- Pressure pre-set valve on request (standard equipment for the solenoid valves).
- Glycerine-damped pressure gauge, $\varnothing 100$ mm, class 1.0%.
- Control by manual directional valve (with motor start-stop remote control) or solenoid valve with pendant remote control box.



RPES 10 to 23 t

Technical data model RPY and model RPES

Model	EAN-No. 4025092*	Frame design	Capacity t	Cylinder model	Cylinder stroke (mm)	Piston return	Type of pump	Control valve	Pump model
RPY-1015 M-2	*157346	bench press	10	YS-10/150	150	spring	manual	manual	HPS-2/0.7 A
RPY-1025 EM-1	*160742	bench press	10	YS-10/250	250	spring	electric	manual	PYE-03/3/10/3M-S
RPY-2316 M	*157360	bench press	23	YS-23/160	160	spring	manual	manual	HPS-2/0.7 A
RPY-2325 M	*157384	bench press	23	YS-23/250	250	spring	manual	manual	HPS-2/2 A
RPY-2325 EM-1	*160759	bench press	23	YS-23/250	250	spring	electric	manual	PYE-03/3/10/3M-S
RPES-1015 M-2	*162579	floor press	10	YS-10/150	150	spring	manual	manual	HPS-2/0.7 A
RPES-1025 EM-1	*160773	floor press	10	YS-10/250	250	spring	electric	manual	PYE-03/3/10/3M-S
RPES-2316 M-2	*160780	floor press	23	YS-23/160	160	spring	manual	manual	HPS-2/0.7 A
RPES-2325 M-2	*160797	floor press	23	YS-23/250	250	spring	manual	manual	HPS-2/0.7 A
RPES-2325 EM-1	*160803	floor press	23	YS-23/250	250	spring	electric	manual	PYE-03/3/10/3M-S
RPY-5015 EM	*158992	floor press	50	YH-50/150	150	hydraulic	electric	manual	PY-04/2/5/4M
RPY-5035 EM	*157575	floor press	50	YH-50/350	350	hydraulic	electric	manual	PY-04/2/5/4M
RPY-5035 EE	*157582	floor press	50	YH-50/350	350	hydraulic	electric	solenoid	PYS-07/3/10/4 E
RPY-5050 EE	*159012	floor press	50	YH-50/500	500	hydraulic	electric	solenoid	PYS-07/3/10/4 E
RPY-10035 EM	*157599	floor press	100	YH-100/350	350	hydraulic	electric	manual	PY-07/3/20/4 M
RPY-10035 EE	*157605	floor press	100	YH-100/350	350	hydraulic	electric	solenoid	PY-07/3/20/4 E
RPY-10050 EM	*157612	floor press	100	YH-100/500	500	hydraulic	electric	manual	PY-07/3/20/4 M
RPY-10050 EE	*158978	floor press	100	YH-100/500	500	hydraulic	electric	solenoid	PY-07/3/20/4 E
RPY-20035 EM	*157629	floor press	200	YH-200/350	350	hydraulic	electric	manual	PY-11/3/20/4 M
RPY-20035 EE	*157636	floor press	200	YH-200/350	350	hydraulic	electric	solenoid	PY-11/3/20/4 E
RPY-20050 EM	*157643	floor press	200	YH-200/500	500	hydraulic	electric	manual	PY-11/3/20/4 M
RPY-20050 EE	*159142	floor press	200	YH-200/500	500	hydraulic	electric	solenoid	PY-11/3/20/4 E

Code explanation

- Valve control : M = manual pump, E = solenoid valve with pendant remote control
- Pump : M = manual pump, E = electric pump
- Piston stroke : 15 = 150 mm, 16 = 160 mm, 25 = 250 mm, 35 = 350 mm, 50 = 500 mm
- Capacity, max. : 10 = 10 t, 23 = 23 t, 50 = 50 t, 100 = 100 t, 200 = 200 t
- Model

Dimensions model RPY and model RPES

Model	RPY-10	RPY-23	RPES-10	RPES-23	RPY-50	RPY-100	RPY-200
Amin., mm	-	-	50	50	350	245	320
Amax., mm	440	440	930	930	900	805	1000
B, mm	380	380	700	700	800	1000	1000
C, mm	510	510	-	-	1000	1300	1400
D, mm	-	-	500	500	1230	1430	1580
E, mm	180	180	-	-	810	860	1040
F, mm	-	-	150	150	140	140	170
G, mm	-	-	-	-	265	335	450
H, mm	840	840	1695	1695	2000	2000	2430
I, mm	300	300	245	245	305	395	550
K, mm	-	-	-	-	1000	1000	1000
L, mm	-	-	-	-	350	350	400
Weight approx.,	86	86	130	130	880	1290	2800

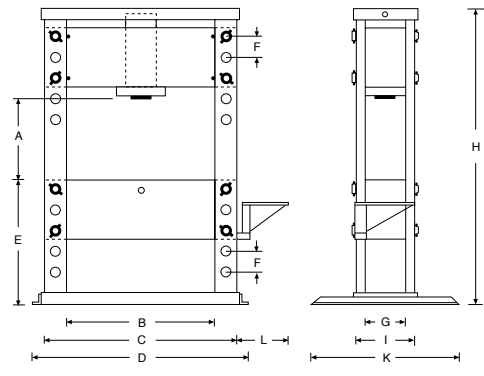

RPY 50, 100 and 200 t

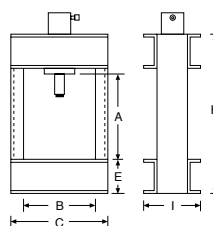

RPY 10 and 23 t

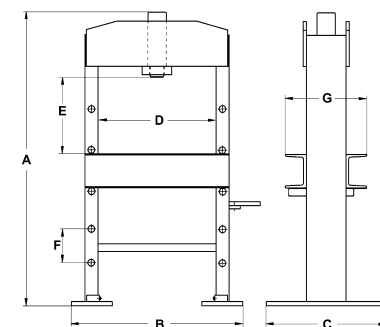

RPES 10 and 23 t

Workshop presses are delivered ready to use.

Selection chart for single-acting systems

Which hand pump fits to which hydraulic cylinder?

The appropriate hand pump model basically depends on the oil volume of the selected hydraulic cylinders. To assist you in your choice please find proposals for the most common cylinders in our range.

How to find the right hand pump in the following charts?

The chosen hydraulic cylinder can be found in the first column.

Several hydraulic cylinders connected to one hand pump:

In those cases where several hydraulic cylinders are connected to one hand pump, the oil volume must be multiplied by the number of connected cylinders. The reservoir of the hand pump must be at least equal to the required total oil volume (plus reserve). If the reserve is very small it may be necessary to top up the reservoir after the air bleeding procedure, depending on the length of the hydraulic hose. During further operation there is no need to consider the volume of the connected hydraulic hose (regardless of the length) because hoses always remain filled.

Double-acting systems:

Please note that while advancing a double-acting cylinder about 1/3 of the cylinder's oil volume flows back to the reservoir (coming from piston chamber). After the air-bleeding procedure both oil chambers will remain filled.



! Please contact us for any questions regarding the configuration of complex systems acc. to your specific requirement.

Selection chart for single-acting systems

Model	Oil volume cm ³	Hand pumps single-stage HPS - 1/0.7 A 700 cm ³	Hand pumps two-stage HPS - 2/0.3 A 300 cm ³	Hand pumps two-stage HPS - 2/0.7 A 700 cm ³	Hand pumps two-stage HPS - 2/2 A 2000 cm ³	Hand pumps two-stage HPS - 2/4 A 4000 cm ³	Hand pumps two-stage HPS - 2/6.5 A 6500 cm ³
YS-5/15	11	+++	+++	-	-	-	-
YS-5/25	18	+++	+++	+++	-	-	-
YS-5/75	53	+++	+++	+++	-	-	-
YS-5/127	90	+++	+++	+++	-	-	-
YS-5/180	127	+++	+++	+++	-	-	-
YS-10/25	37	+++	++	+++	-	-	-
YS-10/50	73	+++	++	+++	-	-	-
YS-10/150	218	+++	-	+++	-	-	-
YS-10/200	291	+++	-	+++	-	-	-
YS-10/250	363	+++	-	+++	++	-	-
YS-10/300	463	++	-	+++	+++	-	-
YS-15/25	53	+++	++	+++	-	-	-
YS-15/50	106	+++	++	+++	-	-	-
YS-15/100	213	+++	-	+++	++	-	-
YS-15/150	319	+++	-	+++	+++	-	-
YS-15/200	425	++	-	+++	+++	-	-
YS-15/250	531	++	-	+++	+++	-	-
YS-15/300	637	-	-	-	+++	-	-
YS-15/350	744	-	-	-	+++	-	-
YS-23/25	83	+++	-	+++	++	-	-
YS-23/50	166	+++	-	+++	++	-	-
YS-23/100	332	+++	-	+++	++	-	-
YS-23/160	531	++	-	+++	+++	-	-
YS-23/210	697	-	-	-	+++	-	-
YS-23/250	830	-	-	-	+++	-	-
YS-23/300	996	-	-	-	+++	-	-
YS-23/345	1145	-	-	-	+++	-	-
YS-30/125	552	++	-	+++	+++	-	-
YS-30/200	884	-	-	-	+++	-	-
YS-50/50	355	++	-	+++	+++	-	-
YS-50/100	709	-	-	-	+++	-	-
YS-50/160	1135	-	-	-	+++	-	-
YS-50/320	2269	-	-	-	-	+++	++
YS-70/150	1478	-	-	-	+++	+++	++
YS-70/330	3252	-	-	-	-	++	+++
YS-100/100	1432	-	-	-	+++	++	++
YS-100/200	2863	-	-	-	-	+++	++
YLS-10/35	51	+++	+++	+++	-	-	-
YLS-20/45	128	+++	++	+++	-	-	-
YLS-30/60	266	++	++	+++	-	-	-
YLS-50/60	426	++	-	+++	+++	-	-
YLS-100/55	788	-	-	-	+++	-	-
YFS-10/11	16	+++	+++	+++	-	-	-
YFS-20/15	31	+++	+++	+++	-	-	-
YFS-50/15	107	+++	++	+++	-	-	-
YFS-100/15	215	+++	-	+++	-	-	-
YCS-12/40	71	+++	+++	+++	-	-	-
YCS-12/75	132	+++	+++	+++	-	-	-
YCS-21/50	153	+++	++	+++	++	-	-
YCS-21/150	458	+++	-	+++	+++	-	-
YCS-33/60	287	+++	-	+++	-	-	-
YCS-33/150	716	-	-	-	+++	-	-
YCS-57/70	562	++	-	+++	+++	-	-
YCS-62/150	1330	-	-	-	+++	-	-
YCS-93/75	990	-	-	-	+++	-	-

+++ recommended hand pump

++ these combinations can also be used, but the oil volume of the hand pump is quite small

- these combinations should not be chosen, because the oil volumes of the hand pumps are too small to fill the selected cylinder (resp. too large and bulky)

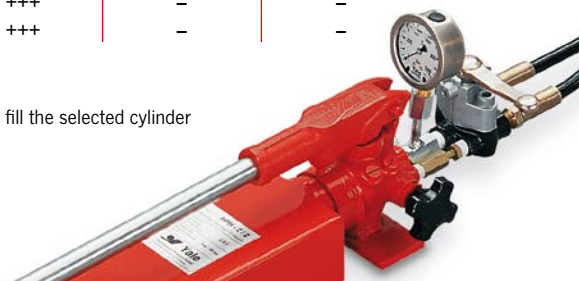

Selection chart for double-acting systems

Model	Oil volume cm ³	Hand pumps two-stage HPH - 2/0.7 A 700 cm ³	Hand pumps two-stage HPH - 2/2 A 2000 cm ³	Hand pumps two-stage HPH - 2/4 A 4000 cm ³	Hand pumps two-stage HPH - 2/6.5 A 6500 cm ³	Hand pumps two-stage HPH - 2/10 A 10000 cm ³
YCH-33/150	716	++	+++	-	-	-
YCH-33/250	1200	-	+++	++	-	-
YCH-62/250	2220	-	+++	+++	-	-
YCH-93/250	3320	-	-	+++	++	-
YCH-100/40	578	+++	+++	-	-	-
YCH-140/200	4080	-	-	+++	++	-
YH-5/30	21	+++	-	-	-	-
YH-5/80	57	+++	-	-	-	-
YH-5/150	106	+++	-	-	-	-
YH-10/30	44	+++	-	-	-	-
YH-10/80	116	+++	-	-	-	-
YH-20/50	142	+++	++	-	-	-
YH-10/150	218	+++	-	-	-	-
YH-10/250	363	+++	++	-	-	-
YH-20/150	424	+++	+++	-	-	-
YH-20/250	707	++	+++	-	-	-
YH-30/200	884	-	+++	-	-	-
YH-30/350	1547	-	+++	-	-	-
YH-50/150	1064	-	+++	-	-	-
YH-50/350	2481	-	++	+++	-	-
YH-50/500	3544	-	-	+++	++	-
YH-70/150	1478	-	+++	-	-	-
YH-70/350	3449	-	-	+++	++	-
YH-100/50	716	++	+++	-	-	-
YH-100/150	2148	-	++	+++	-	-
YH-100/350	5010	-	-	++	+++	-
YH-100/500	7157	-	-	-	++	+++
YH-200/150	4253	-	-	++	+++	-
YH-200/350	9924	-	-	-	++	+++
YH-200/500	14177	-	-	-	-	+++

+++ recommended hand pump

++ these combinations can also be used, but the oil volume of the hand pump is quite small

- these combinations should not be chosen, because the oil volumes of the hand pumps are too small to fill the selected cylinder (resp. too large and bulky)

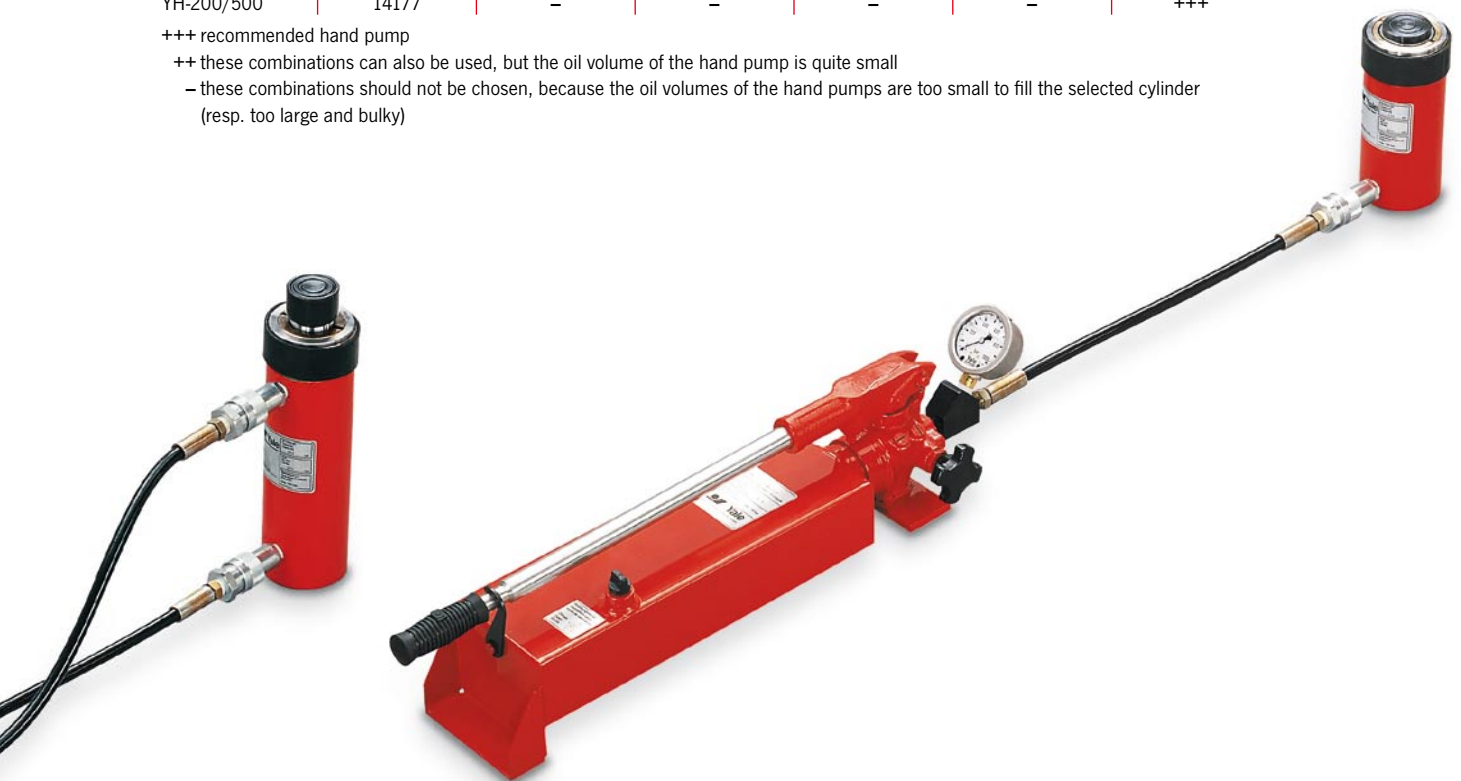

Pump and cylinder speed chart

Hand pumps

For hand pumps the figures given correspond to the number of pump strokes to achieve a piston travel of 10 mm.

Power pumps

For power pumps the piston travel speed is indicated in mm/sec.

Double-acting hydraulic cylinders

Please note that double-acting cylinders (YCH, YH and YEH) always retract faster than they advance, due to the different oil chamber volumes.

Reservoir volumes

The reservoir volumes of hand pumps shall at least correspond to the oil volume which is necessary to advance all connected hydraulic cylinders (plus reserve). Motor pump reservoirs should have at least twice the total required oil quantity (better 3 or 4 times) depending on the operation conditions. For continuous operation choose extra large reservoirs to avoid excessive heating-up of the hydraulic oil.

Hand pumps

Cylinder size t	Number of pump strokes for 10 mm strokes	
	HPS - 2/0.7 A to HPS - 2/10A ND	HPS - 1/0.7 A to HPS - 2/10A HD
5	1	4
10	1	7
15	2	11
20	2	14
21	2	15
23	3	17
30	3	22
33	4	24
50	5	35
57	6	40
62	7	44
70	8	49
85	9	61
93	10	66
100	11	72
140	15	100
200	22	142
220	24	157
340	32	205
430	47	308
560	62	402
670	74	481
880	97	628

ND = Low pressure stage (unloaded stroke)
HD = High pressure stage (loaded stroke)



Power pumps

Cylinder size t	Piston travel speed in mm/sec.												
	PY - 04 ND	PY - 04 HD	PY - 07 ND	PY - 07 HD	PY - 11 ND	PY - 11 HD	PY - 22 ND	PY - 22 HD	PYE - 40 HD	PYE - 55 HD	PYE - 75 HD	PYE - 110 HD	PYE - 180 HD
5	99.9	5.4	155.9	14.2	-	-	-	-	63.8	-	-	-	-
10	48.7	2.6	75.9	6.9	103.5	11.5	-	-	31.1	46	69	-	-
15	33.3	1.8	51.9	4.7	70.8	7.9	-	-	21.2	31.5	47.2	62.9	-
20	25.0	1.4	39.0	3.5	53.2	5.9	106.9	12.4	15.9	23.6	35.4	47.3	75.0
21	23.2	1.3	36.1	3.3	49.3	5.5	99.1	11.5	14.8	21.9	32.8	43.8	69.5
23	21.3	1.2	33.2	3.0	45.3	5.0	91.1	10.6	13.6	20.1	30.2	40.3	63.9
30	16.0	0.9	24.9	2.3	34.0	3.8	68.4	7.9	10.2	15.1	22.7	30.2	48.0
33	14.8	0.8	23.1	2.1	31.5	3.5	63.4	7.4	9.5	14	21	28.0	44.5
50	10.0	0.5	15.6	1.4	21.2	2.4	42.6	4.9	6.4	9.4	14.1	18.8	29.9
57	8.8	0.5	13.7	1.2	18.7	2.1	37.7	4.4	5.6	8.3	12.5	16.7	26.4
62	8.0	0.4	12.4	1.1	17.0	1.9	34.1	4.0	5.1	7.5	11.3	15.1	24.0
70	7.2	0.4	11.2	1.0	15.3	1.7	30.7	3.6	4.6	6.8	10.2	13.6	21.5
85	5.8	0.3	9.0	0.8	12.3	1.4	24.7	2.9	3.7	5.4	8.2	10.9	17.3
93	5.4	0.3	8.4	0.8	11.4	1.3	22.9	2.7	3.4	5.1	7.6	10.1	16.1
100	4.9	0.3	7.7	0.7	10.5	1.2	21.1	2.5	3.2	4.7	7.0	9.3	14.8
140	3.5	0.2	5.5	0.5	7.5	0.8	15.0	1.7	2.2	3.3	5.0	6.7	10.6
200	2.5	0.1	3.9	0.4	5.3	0.6	10.7	1.2	1.6	2.4	3.5	4.7	7.5
220	2.2	0.1	3.5	0.3	4.8	0.5	9.6	1.1	1.4	2.1	3.2	4.3	6.8
340	-	-	2.7	0.2	3.7	0.4	7.4	0.9	1.1	1.6	2.4	3.3	5.2
430	-	-	1.8	0.2	2.4	0.3	4.9	0.6	0.7	1.1	1.6	2.2	3.4
560	-	-	1.4	0.1	1.9	0.2	3.8	0.4	0.6	0.8	1.2	1.7	2.6
670	-	-	1.1	0.1	1.6	0.2	3.1	0.4	0.5	0.7	1.0	1.4	2.2
880	-	-	0.9	0.1	1.2	0.1	2.4	0.3	0.4	0.5	0.8	1.1	1.7

ND = Low pressure stage (unloaded stroke)

HD = High pressure stage (loaded stroke)

- = combination not recommended resp. not possible

